



wise matters

Explorations of Creativity

A review for educators
and policy making

HELEN ABADZI, UNIVERSITY OF TEXAS AT ARLINGTON

MARIALUISA MARTELLI, UNIVERSITY OF ROME

SILVIA PRIMATIVO, UNIVERSITY OF ROME

02

wise

world innovation summit for education

مؤتمر القمة العالمي للابتكار في التعليم

an initiative of  مؤسسة قطر
Qatar Foundation

Explorations of Creativity

A review for educators
and policy making

HELEN ABADZI, UNIVERSITY OF TEXAS AT ARLINGTON

MARIALUISA MARTELLI, UNIVERSITY OF ROME

SILVIA PRIMATIVO, UNIVERSITY OF ROME

Contents

Executive Summary	6
Frequently Asked Questions	14
Introduction	16
A. Creativity: The Driving Engine of Human Evolution	16
B. What is Creativity?	18
C. How is Creativity Measured in Research?	19
Inset 1 - Memory, Intelligence and Creativity	24
1. Creativity and Cognition: Unusual Connections in Memory	26
A. Stages and Processes of Idea Generation	26
B. The Rate of Creative Products and the Role of Memory	24
C. Evidence of Memory Effects: 'Mind-Opening' Experiences for Creativity	31
D. A Creativity 'Theory of Everything'	33
E. Creativity for All: A Scale of Graded Cs	34
F. Creativity Changes Through the Lifespan	36
G. Gender and Creativity	36
Inset 2 - The Neuroscience of Creativity: Essential Concepts	38
2. Creativity and Neuroscience: Glimpses into Idea Generation	40
A. The Revelations of Cognitive Neuroscience	40
B. Eminent Creativity: Daydreaming While Focused on a Task?	41
C. Why Fatigue and Distraction may Bring Creative Ideas	42
D. The Effects of Various Substances on Creativity	43
E. The Neuroscience of Insight	44
F. Some Conclusions from Neuroscience	45
3. Moods and Personality Variables	46
A. How Mood, Perseverance and Persistence Influence Creativity	46
B. The Personality Traits of Creative Individuals	48
C. The Dark Side of Creativity: Some Side Effects?	49

4. Group Processes and the Social Effects on Creativity	50
A. Creativity and Societal Norms	50
B. Brainstorming, Teamwork, and Creativity	51
C. The Effects of Work ‘Climate’ on Creativity	53
5. Creativity and Educational Applications	56
A. Fostering Creativity in Education	56
B. Domain Specificity and Enrichment	59
C. The Efficacy of Creativity Training	61
D. The Long-term Effects of Training	62
E. Are Creativity Scores Dropping in Some Countries?	63
F. OECD’s Efforts to Assess Creative Problem-solving Internationally	63
6. Conclusions and Implications	68
Endnotes	76
Appendices	77
References	80
Glossary	96



Key to symbols used in this document:

- Executive functions*: the asterisk invites you to consult the **glossary** for a definition.
- [83]: the numbers between brackets refer to scientific research studies. The reference for each of these numbers can be found in the **References** section at the end of the document.
- 1) All notes are available in the **Endnotes** section.

Executive Summary

Creativity has been the driving engine of human evolution. The ability of the homo sapiens brain to find unusual solutions to various problems has carried humanity from stone tools to quantum computers. Natural selection and competition for resources have refined over the millennia the expression of this trait in genetic and cultural terms.

In the 21st century there is a surprisingly high demand for creative thinkers. Thousands of studies have been conducted, countless books and articles have been written. Scores of training programs have been implemented. Research started in the United States in the 1950s, but it is now also undertaken in countries such as China, India, and Brazil.

Which popular beliefs about creativity are valid? The research reveals intriguing mechanisms and mysterious linkages. Multiple strands of research are woven in this document, and they reveal the state of knowledge in mid-2014; they also offer some hints on how to benefit from it in your life and work.

“ Solutions deemed innovative are unusual, involving the combination of ideas that rarely go together. ”

“ Some quality commonly understood as ‘creativity’ clearly exists. Its correlates and changes can be detected in the brain. Therefore creativity is not just a social construct or a mere extension of memory functions. ”

What is creativity?

Creative thinking is characterized by unusual ideas and distant associations. To be considered creative in scientific terms, an idea must be **original or novel** and also **appropriate, useful, relevant to a task**. Innovation is a product of creativity. Solutions deemed innovative are unusual, involving the combination of ideas that rarely go together.

The relationships among the variables related to creativity are usually complex and non-linear. Some aspects characterize all creative output, but others are particular to specific domains, such as art, or are more likely to appear under specific circumstances. To assess creativity, human judgment is essential, and cultural norms vary. Nevertheless, some quality commonly understood as ‘creativity’ clearly exists. Its correlates and changes, however defined, can be detected in the brain. Therefore creativity is not just a social construct or a mere extension of memory functions.

Creativity is for all

Everyone is creative. Expression is only a matter of degree and frequency. According to the Four C Model of creativity, small children may have ‘mini-c’, and for daily tasks we have ‘little-c’. With effort and practice one can attain professional level or ‘Pro-c’. ‘Big-C’ is reserved for rare geniuses.

Very roughly, creativity comes from two rather distinct sources:

- knowledge, memory, fast native intelligence, perseverance,* strategy, attention;
- unusual connections and daydreams made by the brain when it is at rest.

The co-existence of the two sources may multiply the creative output.

Relatively average people seem to rely more on their knowledge and memory. People with ‘Big-C’ creativity are rare. They may have a resting-state network in the brain that is overly active even when they are focused.

“ Everyone is creative. Expression is only a matter of degree and frequency. ”

This tendency is frequent among people who have mild degrees of mental illness; it is one reason why some eminently creative people have peculiar personalities. More average people have access to this resting-state brain network during moments of relaxation, sleep, fatigue, distraction, meditation, or sleep. This is why creative solutions may be found under such circumstances.

The brain features that facilitate creativity are to some extent inherited. However, the creative solutions themselves are a part of the human knowledge store. One reliable way to access them is through education.

The primacy of knowledge and enrichment experiences

To become more creative, people need prior knowledge. Particularly important is the plentiful and automatized information that rushes into someone's mind as he or she thinks. This is one reason why creativity depends on education. Feats of engineering, for example, are much more likely when someone already knows a lot about the subject.

Preparation for creativity also needs enrichment experiences that habituate minds to changing domains* quickly and flexibly. Multicultural experiences, multilingualism, challenging choices, life in cities, even adverse conditions force people to connect parts of their memory network* that do not normally connect. Perseverance* to overcome adversity or convince others may also build executive control, which in itself is important in obtaining creative answers.

A somewhat counterintuitive implication for schools is time-related. Creativity requires both time to automatize the skills necessary for a level of education as well as time to engage in complex, critical thinking about content. Some students may feel bored with memorizing essential facts and automatizing skills such as math operations. However, memory functions require the speed and easy access that practice develops.

Training for creativity

Training programs for creativity work well overall. Options are available from preschool to universities. Programs are particularly useful for relatively average students and for teaching the bedrock concepts involved in problem definition and solving strategies. For school-aged students creativity training may be most conveniently integrated into school curricula. There is a need, however, to assess long-term training effects.

Training tends to improve performance in a specific field, such as science, rather than in all fields. One reason is that training improves the performance of brain networks that are involved in a task. If math activates different networks than music composition, then enhancing math strategies may not create better music composers.

Managing creativity

In workplaces or educational institutions there is often a need to maintain a stream of creative productions. A positive mood may activate some workers but not all. Creativity may be optimized through a ‘yin and yang’ between demands and time to relax, permitting some solutions to come. Unremitting attention towards solving a problem, accompanied by caffeine, may facilitate a correct solution, but it may not be the most creative.

Teamwork has been greatly emphasized with respect to innovations, but group dynamics may reduce the creative productions of some people. In some respects it may be best if people think of ideas on their own and interact anonymously with the group (e.g. through software). However, team competition or moderate task conflicts may increase creative output.

Addressing equity

Opportunities for creativity could benefit from greater social equity. Rural and poor populations have less exposure to urban variability; the gap between urban and rural test scores is wide in most countries, and PISA scores in OECD countries illustrate it. Efforts are needed to help close it.

Recommendations regarding creativity enhancement

For public and private agencies supporting policy-making:

State-of-the-art research is necessary

Much of the creativity research thus far has been academic, with few immediate applications. One reason has been the complexity of concepts. It is difficult to generalize findings to the entire population, or even to clearly defined groups of people. Furthermore, most research has originated in North America and has been conducted on conveniently available samples of people rather than representative populations.

- Additional research is needed to validate prominent findings and disentangle cultural from biological and from memory-related variables.
- Research should also aim to understand better the advantages and limitations of lower-income populations in creativity and innovation.
- One of the many issues that must be researched is the progression from the different levels of creativity, from 'little-c' to 'Pro-c' and to 'Big-C' for instance. Though 'Big-C' appears to be qualitatively different, certain educationally accomplished people probably perform at the level of 'Big-C' in earlier centuries.
- Certain studies have shown that it is possible to enhance fluid intelligence* through practice. However, much more research is needed to understand the conditions under which the effect will be sustainable and available to users.

Advances in neuroimaging and the biological mechanisms related to creativity will probably drive significant research in the future and result in more specific recommendations.

For education leaders and policy-makers:

Provide high-quality education at all levels

The simplest way to enhance creativity is to give students of all levels a complex memory network* where knowledge is accessible in milliseconds. This means highly automatized prerequisite skills as well as critical thinking.

- To do so, instructional time must be used for contemplation of content as well as for practice in content fluency.
- Strengthening of programs that provide enriching experiences, such as multilingualism, study abroad and related experiences would also help students become more 'open-minded' and flexible in their thinking.
- Courses specifically aimed at creative problem-solving may enhance the probability that students will integrate these components for the long term.
- Integration into curricula facilitates implementation. Further research is needed on the best modalities that can do this.
- Assessment of the students' potential should be performed prior to domain-specific creative training. This can be based on creative problem-solving and divergent thinking tasks.

For educational practitioners:

Give creativity opportunities to enter schools

Schools have been encouraged to reduce stress on students, partly in the hope that happy students will be more creative. However, instilling a good mood is insufficient. The desire to act is important, either due to a positive or due to a negative mood. Research suggests that creativity results from strictures and a need to find answers. Without exceptional self-control or discipline, it is unclear how many students can produce highly creative ideas when there is no need to do so.

- Paradoxically, it may be useful to push students with deadlines and demands, while at the same time providing time for relaxation or distraction that may bring about the creative solutions sought.
- Teacher training to enhance domain-specific creativity is crucial in schools.

For parents:

Promote complex basic skills as well as creativity opportunities

As mentioned earlier, the highway to creativity is a complex memory network where knowledge is accessible in milliseconds. This means highly automatized prerequisite skills alongside critical thinking and executive control.*

- Children need lightning-fast calculations, reading, and rich vocabulary. They must become expert in mental math, estimations, and mastery of number line* concepts that help create mental shortcuts.
- Children also need ‘mind-opening’ experiences, such as study or residence in multiple cultures and exposure to fascinating experiences. These might include suitable videogames.
- More research is needed on the development of executive control,* but one potential consideration is perseverance,* grit, and tolerance of boredom to some extent.
- Attention must be given particularly to ensure that girls acquire spatial and mathematical skills.
- Parents may want to promote compassion and equitable treatment for children who are gifted. Some research suggests that children who perform better than most others may feel entitled to special treatment and face potential problems at work and life.
- Creativity relates to the production of useful ideas, and children should be taught to make good use of their creative skills.

For employers and managers:

Develop a ‘climate’ for creativity

Much has been written about the climate that promotes creativity and the levels of trust that accompany it.

- One implication from the research is the management of brainstorming and group work around innovations. Individuals must have the chance to maximize contributions and not be held back by group processes.

- As in the case of educational institutions, it may be preferable to alternate between pressure and relaxation and give employees sufficient time to find creative solutions. Constant focus on solving a problem may bring about solutions that are more commonplace.
- Gender and competition: Competition among male teams may ramp up creativity, but for women collaborative undertakings are important. Also research demonstrates a double standard for female social skills. Unlike men, productive and creative women may be considered deficient in social skills and be sidelined. Interpersonal conflict levels must remain low. To maximize creativity, employee management must take these issues into account.
- Creativity at all ages: The creativity of older employees also merits consideration. Longevity and better health mean that such employees may continue to innovate. Responsibility may be well placed in employees who are in good physical condition; they may continue to function well in their advanced years.

Overall, creative competition has resulted in an explosion of innovations over the millennia. But it is probably the first time in history when a significant amount is known about fostering creativity. Though much is yet to be learned, it is possible to put some lessons to work in the hope that more creative citizens will find innovative ways to address some of the pressing challenges of our time.



FREQUENTLY ASKED QUESTIONS

HOW do intelligence and heredity influence creativity?

Anyone can find unusual solutions to various problems. Smarter people may search their memory faster for answers and figure out how to analyze problems. The ability to reason rapidly and fluidly is largely genetic. Also partly genetic is the tendency to fall easily into a daydreaming state that brings up unusual ideas. The actual knowledge that may be produced comes from our personal memories. This is not inherited. Therefore a creative expression is not directly due to intelligence or heredity, but it is facilitated by these factors. See chapter 3, section B and chapter 5, section C.

WHAT is the particular role of early childhood education and play in fostering creative solutions among developing brains?

Young animals and children engage in play in order to develop the skills they will need later in life. Searching for solutions to small problems during play certainly can be creative and beneficial. However, the long-term effects of specific activities on the brain are unknown. Research about pretend-play, for example, shows uncertain benefits. It is unclear at this time how to direct play activities in order to optimize creativity for the long term. See chapter 6, section B.

CAN people learn to become more creative?

Everyone can become more creative; creativity can be taught and encouraged at school and at work. Training is most effective when it teaches the bedrock principles of problem-solving, and average thinkers benefit the most. See chapter 6, section A and C.

ARE there links between creativity and mental illness? Why did some famous artists or mathematicians have mental problems?

People who are actively schizophrenic may be too incapacitated to be creative. But those who share some schizoid* characteristics often have unusual creativity. This is because such people may easily access a brain network that becomes active when people are at rest. Fantasies and eccentric ideas therefore may be easily available to such people. See chapter 3, section B.

HOW to nurture creativity at all ages, particularly among the youngest?

Opportunities for problem-solving at all ages are crucial. The youngest can obtain many opportunities for creativity, for example through free play. One population that is sometimes neglected is older adults. Longevity and a potential for continuing work in old age underline the importance of maintaining the cognitive mechanisms that bring forth creative solutions despite the systemic slowdown. See chapter 2, section F.

CAN teachers become better able to nurture creativity in schools?

In principle all teachers can. In practice, effective training programs are necessary. Ability to benefit from them depends on working memory*, quick thinking, a good knowledge store, and desire to help students. Teachers who can rise to the circumstances may be able to nurture creativity. See chapter 2, section C and chapter 6, section A.

How to design environments conducive to the expression of creativity and innovation?

Managers and teachers must give clear signals to staff or learners that creative efforts are to be rewarded. Individuals must be rewarded for taking risks, even if there are no results. Most important, workers or students must have enough time to think through various alternatives and arrive at the most appropriate solutions. See chapter 5.

How to design assessments for creative thinking and how to enhance performance on the basis of the assessments?

Assessments for creative thinking often test for divergent thinking,* that is for uncommon ideas. These include alternative uses of objects, remote associations of common concepts, overcoming knowledge constraints,* finding difficult solutions. Response rates and originality are measured. Within specific domains,* such as arts or sciences, training can enhance such responses. It is unclear, however, whether training will increase creative responses for the long term. See chapter 6.

How to nurture the evolution from creative thinking to innovative applications?

Utility is a prerequisite for considering various ideas as creative. Innovative applications, however, must go through stages of economic and practical feasibility testing to improve performance, monitoring and evaluation, and dissemination. Creators must be able to convince stakeholders. Most important, innovations must find people willing to adopt them. See chapter 1, sections A and B.

Are academic testing and performance needs reducing creativity?

Since the 1970s, the Torrance creativity test scores in the U.S. have dropped. This has happened despite increasing investments in education and creativity. Sometimes this has been linked to an excessive focus on homework and testing, which in the U.S. earlier was limited. Perhaps students do not have enough time for free play to invent infrequent uses for common objects, as measured by the tests. However, the tradeoffs are unclear. Perhaps in the highly technological 21st century, complex academic knowledge may increase the likelihood of obtaining appropriate solutions more than 1960s measures. See chapter 6, section E.

Should government policies seek to encourage creativity for everyone, or just focus on the few outliers who can bring about large-scale change?

In principle the benefit is much larger if everyone becomes a little bit more creative. The creativity programs work best for average people. As for the outliers, many of them enter elite institutions that already exist. There is evidence that large-scale change happens because of a few sponsored outliers. See chapter 2, section E.



Introduction

A. Creativity: The Driving Engine of Human Evolution

Archeologists often discover stone tools made by humans about 60,000 years ago. These artifacts mark a momentous breakthrough for our species. Everywhere on the planet we see the outcomes of what began as a spark of insight in the minds of very ancient people. When the world consisted solely of naturally formed objects, the capacity to imagine something and turn it into a reality may well have seemed almost magical.

In those early times, cranial capacity significantly increased and with this came the ability to access memories voluntarily, independent of cues, and thereby think about events that occurred in the past, or that could occur in the future. With this also came language and the capacity to transmit ideas to other people who imitated them or based their own insights on them [83].

“ The distance between the artifacts of the remote past and the airplanes of today underscores the evolutionary advantages that creativity has offered to humans. ”

Sexual selection has helped ramp up the evolution of creativity. To attract the opposite sex, certain functional forms became exaggerated and ornamental. In this way artifacts, such as pottery, went beyond the realm of practicality to the realm of aesthetic functionality [83].

To record mental products, writing was invented about 7,000 years ago. Philosophical ideas were expressed about 2,500 years ago, the printing press was invented 1,000 years ago, and the modern scientific method developed about 500 years ago.

The past 100 years have yielded a technological explosion that has completely altered the daily routines of humans. The distance between the artifacts of the remote past and the airplanes of today underscores the evolutionary advantages that creativity has offered to humans.

The urge for creativity involves tradeoffs. One consequence is a constant quest for novelty and boredom with repetitive events. Competition for resources has also driven the quest for unusual solutions. Creative undertakings are not always positive, and they may interfere with survival and people's well-being. But overall, creativity has emerged as the great engine of civilization. Now humans have the capacity to understand its functions and to channel it constructively.

The force that drove our ancestors' evolution has been described as the most important economic resource of the 21st century [81]. Humans have taken over the planet, and the competition for scarce resources among nations and companies increases daily. Expanding technology has raised the demand for energy and computing power. Care for human welfare has raised the demand for biomedical discoveries. Political issues and defense have increased demand for complex military systems. Global warming has raised the demand for solutions that transcend current scientific knowledge. Worldwide there is a high demand for people who can derive knowledge or combine it in ways not seen before.

“ Worldwide there is a high demand for people who can derive knowledge or combine it in ways not seen before. ”

As a result, thousands of articles have been written about creativity, and almost every week a new scientific study is published about some of its aspects. At least two journals are dedicated to this field. There is a surfeit of books, sometimes of a philosophical nature [281, 282]. There are self-styled experts, blogs and news articles published as commentaries on various studies. In pop magazines there are lists of do's and don'ts for maximizing creativity and innovation. There are training programs sold by various companies.

Creativity advocates sometimes seem like blind men trying to describe an elephant from touch. The concept is often described through anecdotes, is overused, and almost every belief can find some support. To understand better how to use creativity, it is important to delve into the experimental evidence about this topic and examine various beliefs and recommendations on this basis. (See review methodology in Appendix 1.)

The experimental evidence presented in this review is fascinating. Some issues about the cognitive neuroscience of creativity are complex. Much effort has gone into simplifying and explaining them. While reading, you may also have insights and arrive at your own conclusions about how to use this body of research.

B. What is Creativity?



Figure 1. Ramanujan, the famous Indian mathematician.

The trait of creativity is more visible in artistic domains that people understand best, such as art, music, drama, dance, literature. It is less often viewed as connected with scientific disciplines that require methodological rigor and rationality. References to scientific creativity are sometimes deemed implausible. For example, at the 2014 biennale in Venice, the Guggenheim museum organized a children's workshop on creativity. Children were asked to give examples of something 'creative'. Some answered a painting is creative, dance, music, a sculpture, a drawing. Then a kid said 'science' and everybody laughed.

Is creativity a gift?

"A short uncouth figure, stout, unshaven, not over clean, with one conspicuous feature-shining eyes- walked in with a frayed notebook under his arm. He was miserably poor... He opened his book and began to explain some of his discoveries. I saw quite at once that there was something out of the way; but my knowledge did not permit me to judge whether he talked sense or nonsense."

This is how a founder of the Indian Mathematical Society described his 1911 encounter with Ramanujan, a young South Indian of limited education, who seemed to be possessed by mathematics.

Ramanujan could not explain how he arrived at his deep insights. He believed that he served a local goddess, who reportedly visited him in his dreams and wrote equations on his tongue. In 1913, Ramanujan managed to get admission to Cambridge University in the United Kingdom, where efforts were made to teach him rigorous mathematical methods. But his response was often an avalanche of original ideas, that made instruction hard to continue. While on his deathbed in 1920, he wrote a letter to his mentor, mathematician G. H. Hardy, outlining several new mathematical functions never before heard of, along with a hunch about how they worked. Almost 100 years later, the formulas could explain the behavior of black holes.¹

The many ways to creativity

Popular beliefs consider creativity as an unusual talent, a gift reserved for the few that is innate and cannot be taught or developed. People of unusual creativity have fascinated us [270]. The good news, however, is that **all people have creativity**. Ramanujan or Einstein may have possessed 'Big-C'. But our daily insights and bright ideas are considered a 'little-c'. The people achieving professional-level eminence, such as top physicists or musicians may have 'Pro-c'. **So creativity is for all and can be developed**, as you will see in the following chapters.

Defining creativity

Since the 1800s, there have been debates on how to define creativity. Definitions range from simple, e.g., “the ability to make new things or think of new ideas”² to the complex: “Creativity is the interaction among aptitude, process, and environment by which an individual or group produces a perceptible product that is both novel and useful as defined within a social context” [196]. Some researchers proposed an element of surprise while others thought that creative things should be ‘worthwhile’ [211]. To create common ground for comparable research, many researchers have agreed on certain standards [108, 283, 211]: Creativity should be defined in terms of **originality as well as usefulness** [284].

“ Creative solutions involve the combination of ideas that typically are not linked directly. Unusual ideas and access to distant, remote associations are hallmarks of creative thinking. ”

Creative solutions involve the combination of ideas that typically are not linked directly. Unusual ideas and access to distant, remote associations are hallmarks of creative thinking. If the ideas are transformed into actions, the result is innovation: “the act or process of introducing new ideas, devices, or methods.”³ The definition suggests that **innovation is a product of creativity.**

C. How is Creativity Measured in Research?

Testing creativity

You have just been invited to participate in a study that tests creativity under different conditions. Are you ready? You have two minutes to answer the following question: *What uses can you find for a paper clip?*¹

This is an **alternate uses** test item, in which the participants must note down all the possible uses for an object. It is also considered a **divergent thinking*** test item, which has many possible answers, unlike a **convergent thinking*** test item, which has only a single correct one. [80, 241].

You might also receive a **remote associates** task like this one:⁴

Here are three unrelated words:
time, hair and stretch.

You must come up with the common link.²
Or: *fish, mine, rush.*³

You may also receive a **functional fixedness*** test item (Figure 2):

How to hang a lit candle on the wall when you get a box, matches, thumbtacks, and a candle?

▼ 1
Uses for a paper clip include: Holding papers together, cufflinks, earrings, keychain, imitation mini-trombone, thing you use to push that emergency restart button on your router, keeping headphones from getting tangled up, bookmark, scratching a message in emergency.

▼ 2
The link is the word long.

▼ 3
The answer is gold.

The subjects are asked to attach a candle to the wall and are given a box of tacks, candles, and matches, as shown in panel A.

The solution is shown in panel B.

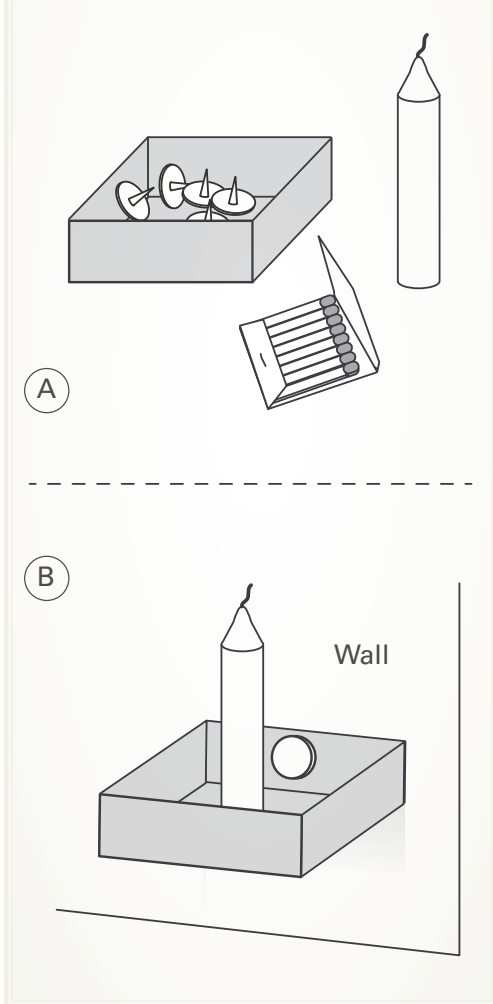

Figure 2.
Testing functional fixedness:
Duncker's Candle Problem (1945).

What is being measured

Your responses to items such as the above would be scored through some of the following characteristics:

Originality – the rarity of responses; for example, using a shoe to stamp an insect is considered a less original or unique idea than using a shoe as a flowerpot [3].

Flexibility – the ability to switch one's thinking between different concepts or tasks, or to think about multiple concepts simultaneously [220]; for example, switching languages effortlessly; therefore how many areas your answers cover (e.g., cufflinks and earrings are both accessories, so they are one area).

Fluency – the rate of responses per minute.

Elaboration – level of detail in responses; 'keeping headphones from getting tangled up' would be worth more than 'bookmark' in the paper clip test.

Executive functions – an umbrella term for the management (regulation, control) of cognitive processes. These include working memory, reasoning, flexibility, problem-solving as well as planning and execution.

“Tests rarely assess cognitive functions directly; the measurements are indirect and approximate, so correlations among various test scores may be modest. This is one reason why multiple measurements are used.”

Assessing the results is complex and approximate

How would scores be produced on the above variables? Creativity is in many respects a matter of judgment. The monumental insights of ancient mathematicians, for example, have become routine geometry exercises for secondary education, and reinventing them today would not be considered creative. Even instructions may affect outcomes across studies. To develop protocols and rate answers, human judges are therefore necessary. And judges have their own constraints. For example, they may judge in-group productions as more creative [5].

Tests rarely assess cognitive functions directly; the measurements are indirect and approximate, so correlations among various test scores may be modest [251]. This is one reason why multiple measurements are used. Overall, various divergent thinking tests reasonably estimate creative thought [210, 195]. Longitudinal research shows that tests of divergent thinking predict later creative performance.

Besides divergent thinking,* some experiments use concepts such as conceptual expansion* which refers to the ability to widen one's knowledge structures to include unusual or novel associations. 'Overcoming knowledge constraints'* refers to the ability to override 'functional fixedness',* the constraining influence imposed by salient or pertinent knowledge [1]. Other tasks may aim to get insights about words or symbols, mental imagery, the generation of creative stories, paintings, or melodies [13, 285, 72, 78, 97, 117, 130].

“ Creative potential can be present in any domain but creative production occurs in the domain in which time and energy are committed. And some general abilities (e.g., intelligence, motivation) play a role in all creative pursuits, regardless of the field in which creativity is being expressed. ”

If you participated in a creativity experiment, you might also undergo one of the brain imaging* technologies aimed at obtaining data from your brain. You would also probably receive surveys and questionnaires aimed at assessing cognitive aptitude, and personality traits. These were developed in order to identify more or less creative people [107, 159, 176, 251, 257, 228].

Various determinants limit predictability

It is impractical to separate research by the circumstances and testing protocols that were used, so studies pertaining to creativity tend to be lumped together in various reviews and meta-analyses. But this becomes a substantial weakness. Straightforward relationships among various creativity determinants are practically nonexistent. Thus it is hard to state that “such and such increases creativity”. Some people make such statements, but these are best applicable to specific circumstances. Consequently, much of the advice given in the popular media is simplistic. It does not take higher-order interactions into account.

Would your responses to the items above predict creativity for math and also for art? Is creativity a general trait or does it arise for specific tasks and circumstances? There is support for both arguments [146].

Some tests, like Torrance Creativity test have been developed using psychometric methods to include items that mainly assess creativity that is manifest in multiple situations. This is because different abilities converge to produce creative outcomes. Creative potential can be present in any domain* but creative production occurs in the domain in which time and energy are committed. And some general abilities (e.g., intelligence, motivation) play a role in all creative pursuits, regardless of the field in which creativity is being expressed.

At the same time, studies investigating various domains, such as arts or science, provide evidence for specificity. Some show low correlations between ratings of creative products in different domains. When trained in certain specific tasks, learners may improve on those but not in others. (See chapter 6 on creativity training.)

Circumstances matter

To respond to the test items above, you were given a short timeframe, such as 1-2 minutes. This is because data must be collected in finite periods of time. But short timeframes also reflect the research finding that emergence of creativity greatly benefits from constraints. The constraints can be in the problem requirements. Examples are rhymes, haiku, and miniaturization of electronic devices. The constraints may spur unusual solutions.

For example, it is said that Ernest Hemingway was once asked to write a novel of six words. And reportedly he wrote “For sale: baby shoes, never worn”.⁵

Real-life problems, urgent questions that need answers are at the heart of a creative process. It has been hugely challenging to explore these processes. They operate below consciousness, and cannot be easily disentangled. We can recognize creative acts when we see them, but we cannot express how we arrived at the decision.

“ Emergence of
creativity greatly benefits
from constraints. ”

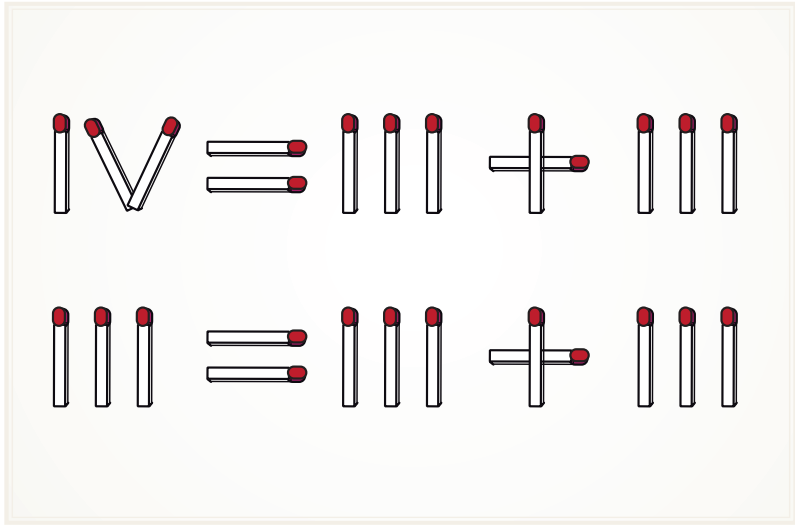

Move any single match so that the false mathematical operations become true.⁴

Where research is leading us

Creativity research has evolved gradually, often by probing commonsense beliefs. Psychologists have examined the mental operations involved in creativity, with behavioral tests such as shown above. From the 1950s to about 2000, a large number of studies were conducted trying to disentangle the cognitive and affective processes involved. The availability of brain imaging since about 1995 offers some glimpses of how the brain works.

The research presented in the following sections shows two rather discrete sets of functions involved in creativity:

- Rapid connections within the networks of our knowledge, propelled by our ability to plan, execute, and persist.
- Use of the brain’s resting-state ‘default network’,* which is involved in relaxation and daydreaming.

These two functions link the rare geniuses, like Ramanujan, to the everyday creativity that all of us exhibit. As is often the case, cognitive psychology and neuroscience give complementary perspectives. The following sections discuss the prominent findings of the research.

To understand the causal chain of theories and models developed by psychologists, a preliminary inset is included on memory operations and on the brain functions involved in creativity. And some cartoons illustrate the humorous beliefs about this concept.

4 ▼ Solution: For the first line, the IV becomes VI. For the second, the + becomes =.



MEMORY, INTELLIGENCE AND CREATIVITY

Your memory is something akin to **the biggest bottle in the world**. It holds all your recollections, and never fills up. Figuratively speaking, it has two parts: the bottle section where your memories are, and the neck of the bottle, where the ‘working memory’ resides.

Long-term memory* is set up in the form of networks. Knowledge items are bound in complex relations to each other into a knowledge or memory network. They are also classified under hierarchical categories. In principle, we have a single network for our memories but in reality it is not easy to link one item to another. Those that are closest in meaning or context are recalled most easily, while those that are further away take longer to recall (see Figure 4). Many items can only be accessed under specific circumstances, if ever.

Figure 3.
A schematic of the memory components

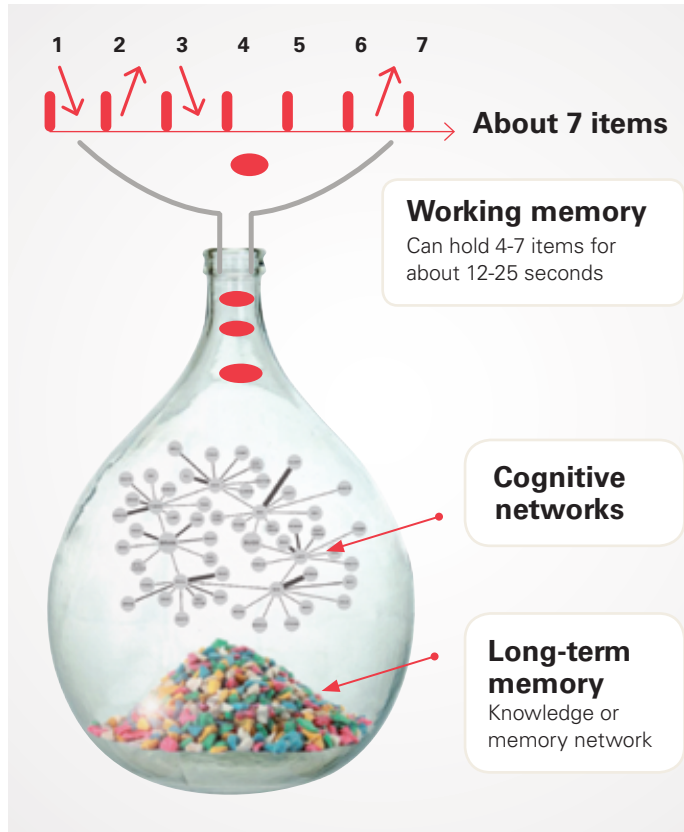

Within a **knowledge network**, concepts are associated with differing strengths to one another. The ease with which a certain concept activates another concept reflects the semantic distance between the two. The word ‘table’, for example, tends to activate more strongly the concept ‘chair’ compared to the alternative concept ‘multiplication’ [3].

Items recalled from long-term storage in order to answer certain questions enter the **working memory**.* This is what is in your mind right now. And it has very limited capacity. It can hold only about 4-7 items for about 12-25 seconds. If it gets erased, people forget what they were thinking. Therefore speed is crucial; finding and retrieving items from the

long-term storage network must take milliseconds. While in working memory, various solutions must be considered, a process that must also be conducted in milliseconds. The flexible retrieval of material from multiple categories is also crucial.

“ Practice in learning and recalling the various concepts binds them into larger chunks that pass through the working memory bottleneck as one piece. ”

To retrieve the items, the knowledge must exist. Some unknown items can be deduced from prior knowledge, but it is difficult to generate in milliseconds knowledge that one does not have. When we search for items in our memory, many parts of our brain are activated and help find them along the paths where those items were learned. This is called ‘spreading activation’.

Practice in learning and recalling the various concepts binds them into larger chunks that pass through the working memory bottleneck as one piece. Those chunks – and the processes that use them – then become hard to break apart. One result is **functional fixedness***, the tendency to view objects as functioning only in their usual ways. Another is called **mental set***, which is the tendency to persist in solving problems the ‘old’ way. These tendencies limit our ability to recognize new alternative solutions.

Intelligence matters in generating answers or solutions. There are two types that are complementary:

Fluid intelligence* is the ability to reason quickly and to think abstractly. People with high fluid intelligence often have a nervous system that responds faster, so they tend to be better at searching their memory and connecting knowledge. The tendency is largely genetic. Fluid intelligence peaks in adolescence and declines progressively after age 30 or 40. The decline is slower for better-educated people who use it intensely.

Crystallized intelligence* involves knowledge that comes from prior learning and past experiences. Situations that require crystallized intelligence include reading comprehension and vocabulary exams. As we age and accumulate new knowledge and understanding, crystallized intelligence becomes stronger.

To solve problems, **executive function*** is necessary. This term includes the ability to direct and maintain attention to an object, to plan and execute tasks in a certain order, and to persevere despite difficulties.

Figure 4. A two-dimensional illustration of a memory network. Adapted from Kenett et al. (2014): Investigating the structure of semantic networks in low and high creative persons.

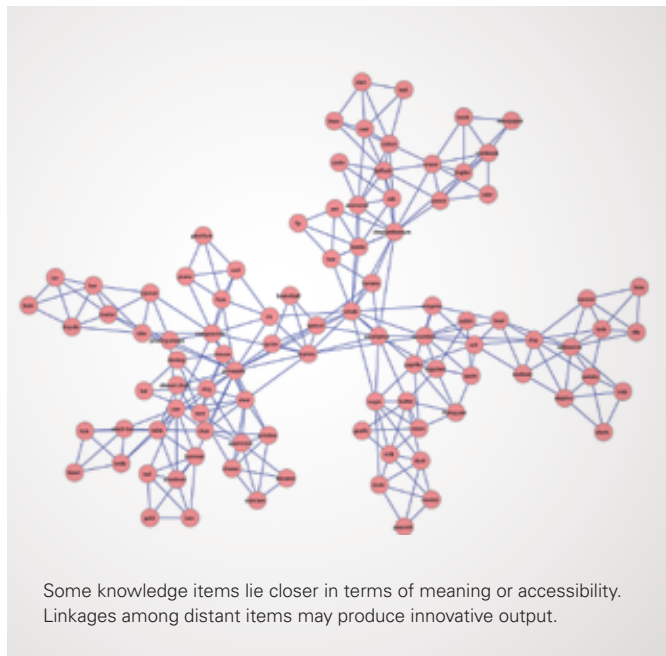

Creativity and Cognition: Unusual Connections in Memory

A. Stages and Processes of Idea Generation

Creative ideas do not usually arise quickly and instantly. Since the 1950s, many studies have explored the nature of underlying processes involved in creativity. This section describes some theories and models that have resulted from the research.

Arriving at satisfactory solutions often takes repeated efforts and iteration: we prepare to solve a problem, we incubate it in our minds, we may have flashes of illumination about it, and finally we verify that the solution is correct [108, 71]. Some people engage in certain stages more than in others, and this has led some researchers to posit that people may have different problem-solving processing 'styles'. The stages are dynamic and interlinked, as expressed in Figure 5.

- A **generation stage** includes the proactive acquisition and generation of new information and the sensing of trends, opportunities, and problems.

- A **conceptualization stage** is when the problem or opportunity identified in the previous stage is analyzed in order to conceptualize the problem domain* comprehensively.

- During an **optimization stage**, alternatives are systematically examined to develop a plan for implementing an optimal solution that can be executed with existing resources.

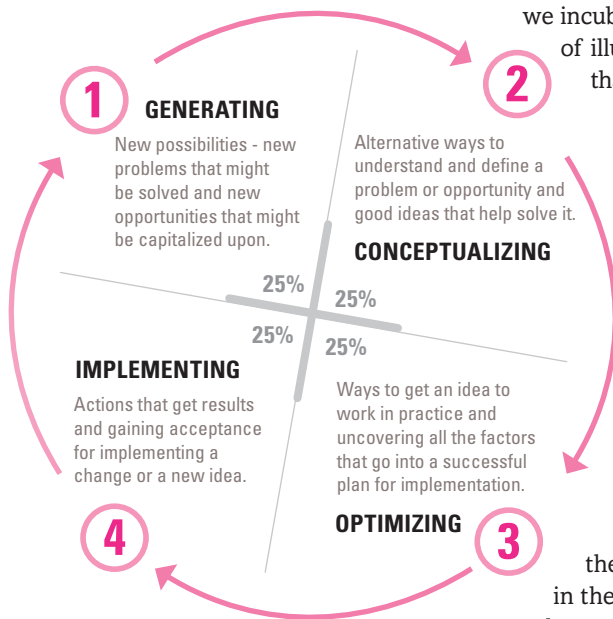

Figure 5. The four stages in the creative process. Adapted from Basadur et al. (2013): Creative Problem-Solving Process Styles, Cognitive Work Demands, and Organizational Adaptability.

- Finally, the **implementation phase**, the individual experiments with the new solution, evaluates the outcomes, and makes adjustments if necessary to successfully implement it.

The theories that creativity results from iterative processes are particularly applicable to the production of creative and novel designs. Designers must start with the ‘first principles’ of previous knowledge, combine earlier elements, modify and transform some of them, use analogies from a slightly different domain,* and cause new functions for a design to emerge (Figure 6).

One key to understanding design creativity is to understand the array of symbol systems that designers utilize. These symbol systems range from being vague, imprecise, abstract, ambiguous, and indeterminate (like conceptual sketches), to being very precise, concrete, unambiguous, and determinate (like contract documents). Design requires judicious application of these transformations. The mind must make associations and also draw inferences [92]. Neuroimaging* research showed indeed that a dual mechanism exists for this function in the prefrontal cortex and is supported by a dissociation of the two hemispheres [96]. The memory architecture supports neuron assemblies that help shift from one thinking mode to the other [86]. Repetitions can make such switching faster and more efficient, so other things being equal, creative productions may increase over time.

To consider how creative the results are, it is important to note whether a design lies outside the range of designs previously produced by any designer in a society or whether it is outside the range of designs produced by its creator [33].

Illustrations of principles

The **combination process** involves the addition of two sets of ideas or some subset of them in order to generate a new and different idea (see Figure 6).

The **transformation** creative process is characterized by the alteration of one or more structure variables by an external process, in order to modify the original product (see Figure 7).

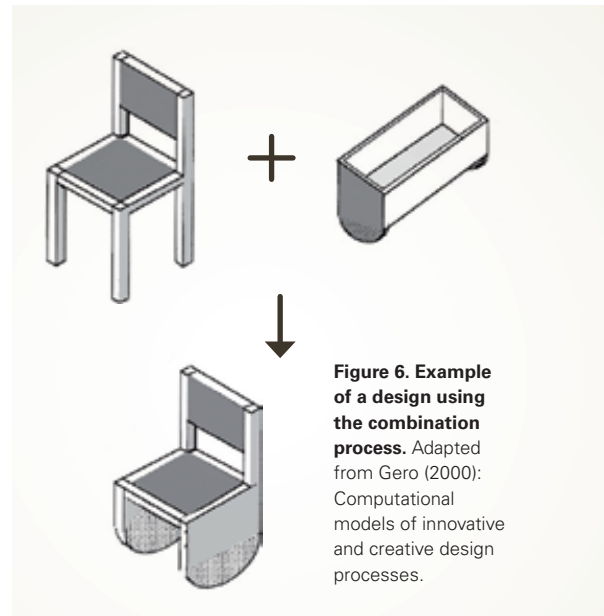

Figure 6. Example of a design using the combination process. Adapted from Gero (2000): Computational models of innovative and creative design processes.

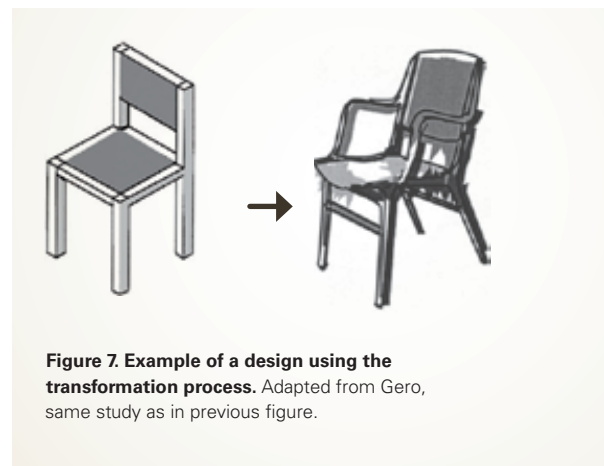

Figure 7. Example of a design using the transformation process. Adapted from Gero, same study as in previous figure.

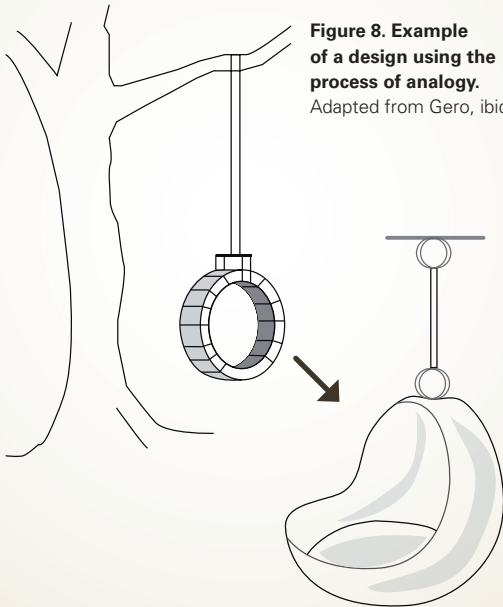

Figure 8. Example of a design using the process of analogy.
Adapted from Gero, *ibid.*

The studies presented above show the range of skills important for creative problem-solving [232]:

- the synthetic skill to see problems in new ways and to escape the bounds of conventional thinking,
- the analytic skill to recognize which innovative ideas are worth pursuing and which are not, and
- the practical-contextual skill of persuading others or 'selling' the value of one's ideas and innovations to other people.

B. The Rate of Creative Products and the Role of Memory

Testing under time constraints reveals some of the processes that generate creativity [21, 25, 93]. If asked to give all the uses of a paper clip within one minute, you may initially respond quickly with the more common uses. As time passes, you will find more creative uses, but the rate of their production will slow down.

This is called the **serial order effect** of creativity. Performance in divergent thinking tasks like unusual uses or impossible situations improves over time [207, 267] as shown in Figure 9.

Analogy is the creative processes through which, after a detailed analysis of one domain,* some specific and coherent variables and the general conceptual structures of that domain are applied and transferred to another domain (see Figure 8).

Emergence is defined as the process by which new functions of an object or of a property are identified over and above their original functions. Finally, the **first principles** process is considered as the effect of the application of previous knowledge about structure and behavior to new fields or objects.

How important is knowledge for the above? On the one hand, we need to know enough material about a field in order to find new solutions. But on the other, well-practiced knowledge about a topic can result in a functional fixedness,* a closed and entrenched perspective. Knowledge may prevent a person from moving beyond the way in which he or she has seen problems in the past. Thus knowledge can enhance or reduce creativity. But the decision to become creative is partly conscious. Given instruction and opportunities to practice, people may engage in it more intensely.

Memory mechanisms are to some extent responsible for this effect. Creative ideas connect concepts that are distant in our memory network, and distant associations take longer to become activated and available [168, 265, 267].

Some people are better at fast idea generation than others. They seem to have richer and more flexible knowledge networks. One hypothesis is that their networks are structured in ways that facilitate quick access to knowledge items.

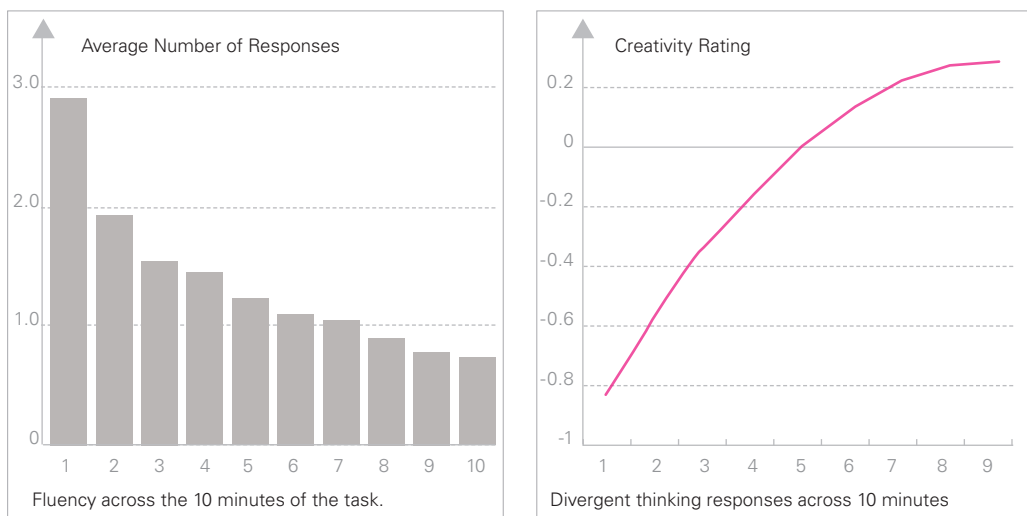

Figure 9. Number of responses produced during a 10-minute task (left panel) and creativity ratings of divergent thinking responses across 10 minutes (right panel). Adapted from Beaty, R.E., & Silvia, P.J. (2012): Why do ideas get more creative across time? An executive interpretation of the serial order effect in divergent thinking tasks.

It seems that creative individuals are characterized by ‘flat’ (broader associations) instead of ‘steep’ (few, common associations) associational hierarchies. Therefore one influential creativity model was based on associations and defined the process of creative thinking as:

“The forming of associative elements into new combinations which either meet specific requirements or are in some way useful. The more mutually remote the elements of the new combination, the more creative the process or solution” [167].

A computational approach to the study of semantic networks [274], through the analysis of free associations, supported this model. The semantic memory network of less creative persons seems to be more rigid, compared to the network of more creative persons. It is more spread out and breaks apart into more sub-parts as shown in Figure 10.

However, this answer is only partly valid. Other studies have shown that creative people did not necessarily have a different organization of their knowledge networks than less creative people [25]. Instead, they were faster in making the associations and changed categories and areas more flexibly. These findings bring to the fore the role of ‘fluid’, fast, genetically-based intelligence. Very intelligent people may traverse distances in their knowledge networks faster than more average people. Research that measured fluid intelligence* alongside divergent thinking* showed that more intelligent people produced creative answers more consistently [223].

“ Creative ideas connect concepts that are distant in our memory network, and distant associations take longer to become activated and available. ”

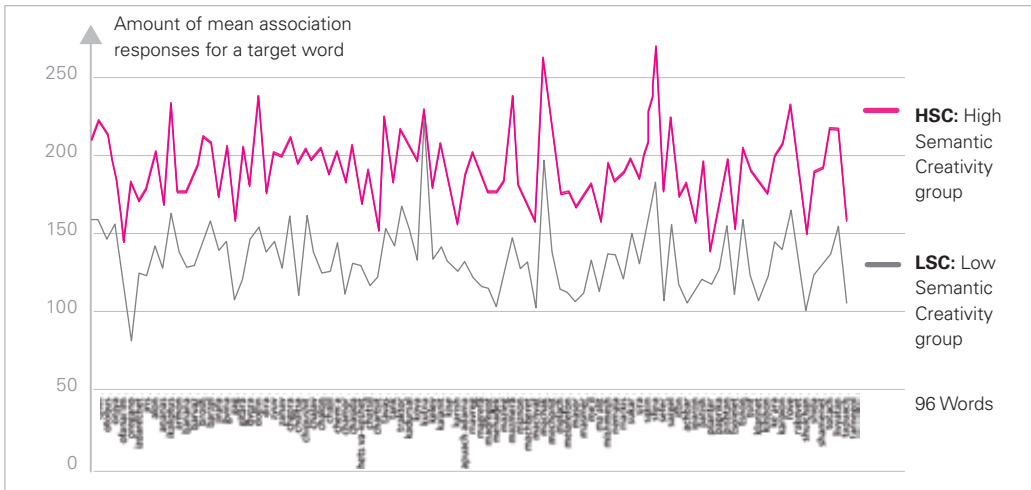

▲ Average unique association responses generated for 96 target words for the low and high semantic creativity groups. In grey are the responses of the low semantic creativity group (LSC), in pink those of the high semantic creativity group (HSC).

Figure 10. Shapes of memory networks of more and less creative people. From Kenett et al. (2014): Investigating the structure of semantic networks in low and high creative persons.

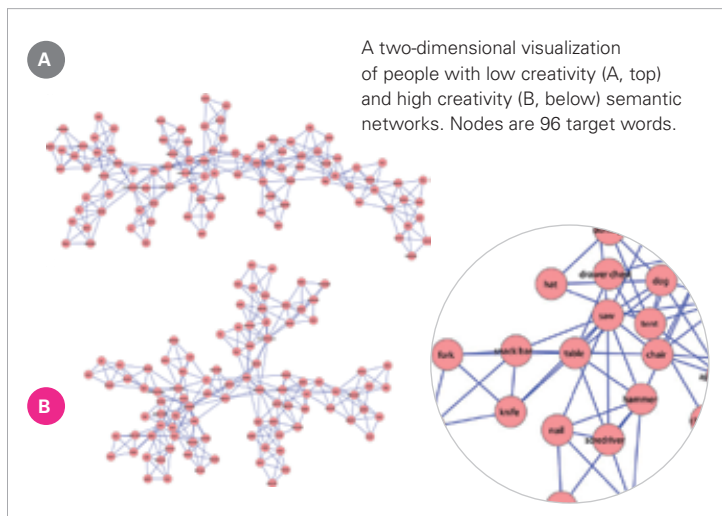

People with high fluid intelligence* use complex strategies more effectively [180], switch idea categories more often [180], manage interference [256], and discern patterns, rules, and structure in complex problems [166]. More creative people may also judge and refine initial ideas [79, 85, 261], then choose and apply more effective idea-generation strategies [93]. These findings suggest that executive functions matter a great deal and contribute enormously to attention and cognition [21, 26, 61, 78, 180, 260, 276, 277].

The importance of executive functions* is evident when considering autism. Many people in the autistic spectrum have deficits in this respect [286, 287, 288, 289, 290, 291, 292, 293, 294, 295].

People who have attention deficit hyperactive disorder (ADHD) also demonstrate the effects of memory and executive functions* on creativity. They may traverse their knowledge networks fast in search of answers, but they have limited attention and may not persevere. One study of adolescents showed that the ADHD group exhibited cognitive advantages and disadvantages. They demonstrated an enhanced ability to overcome the constraining influence of examples, but a reduced capacity to visualize a functional invention [2].

Executive functions* are also deficient in some of their nearest relatives [296, 297, 298]. Many autistic children do little pretend play, and show repetitive and compulsive behaviors [299, 300, 301, 302, 303, 304]. Though some autistic people have phenomenal stores of knowledge, creative expressions among them are rare.

Taken together, these results have multiple implications. Strategic retrieval and rapid manipulation of knowledge are crucial in the consistent production of creative results. Associations of remote concepts are important for the process, and they interact with executive process [93, 28]. Overall, it

takes time for most people to develop a good strategy, overcome interference from obvious ideas, and identify fertile idea categories. People with higher fluid intelligence* use executive functions* better.

It is important to engage the young in creative exercises, so that they will have time in life to improve. To produce consistently creative responses, rapid execution strategies are needed that are the hallmarks of fluid intelligence*. People of average intelligence are likely to produce creative responses to a task, but they may need more time to think. Certain exercises may modify fluid intelligence* [126].

C. Evidence of Memory Effects: 'Mind-Opening' Experiences for Creativity

As mentioned earlier, it helps to know a lot and think fast about what we know, in order to find solutions to various problems. Clearly formal education is one important avenue. Which other experiences facilitate fast and fluid processing of information? Research brings up the importance of unusual or enriching experiences. Examples include:

Bilingualism. At least 24 studies have been conducted, of which 20 found a difference in various creativity measures between monolinguals and bilinguals [201].

Multicultural experiences. In other studies, participants with greater multicultural experience demonstrated higher creativity on domain general tasks compared to monocultural participants (e.g., generating unusual uses for a garbage bag, unconventional gift-giving ideas, and types of occupations) [29, 147, 148].

Studying abroad. In a study led in 2012 in the USA, results showed that a semester spent in Spain or Senegal led to higher creativity scores in general and specific domain tests [146]. To some extent this may show the effects of foreign languages and

multicultural experiences, but dealing with the geography and local customs would add extra dimensions.

Childhood adversity. Many cases are described in popular literature of people who found ways to overcome unexpected problems and obstacles, such as social rejection, parental loss, or physical disability. Most people in such circumstances do not rise to creative eminence. However, several eminent creators had harsh early life experiences [155].

Exposure to unusual or unexpected experiences. Study participants were confronted with apparent violations of physics laws, such as a toy car that moved in their direction, or objects that changed size.

“ People who have adapted to two or more cultures rapidly navigate between different cultural knowledge schemas. ”

Comparisons with various control groups showed that an unusual experience – defined as the active involvement in an unusual event – increased cognitive flexibility more than involvement in normal experiences [204].

A culture-specific theory of creative thinking has been posited to explain the effect of enrichment [29]. People who have adapted to two or more cultures rapidly navigate between different cultural knowledge schemas. These may include learned practices (e.g., eating habits), values (e.g., laws, customs), and beliefs (e.g., religious or spiritual) that individuals habitually apply in a broad range of situations.

This view is supported by learning research. A novel behavioral experience can promote the formation of a long-lasting memory for another task when novelty occurs shortly before or after a learning task [17]. Furthermore, long-term retention is often facilitated by unexpected needs to use the information, in comparison to scheduled, block repetitions [45].

Thus, the commonsense idea that exposure to new and variable ideas ‘opens the mind’ has some basis. Flexibility is achieved by practice in rapidly changing among various categories in one’s cognitive networks, while life experiences increase the available building blocks. Life experiences, from the traumatic to the joyful, can push people outside their normal thought patterns.

The above findings have some socioeconomic implications. Children who live in urban areas may be exposed to more, and diversified experiences. Those who live in families with less education and attend schools that have few resources similarly may not be sufficiently challenged to learn. One implication of this is a potential creativity gap among rich and poor. Disadvantaged students score below the better-off in all topics related to problem-solving (OECD, 2012). To some extent, the situation brings up the urban-rural performance divide, which exists nearly everywhere in the world, from India to Canada. Life in cities exposes children to multiple unexpected events that they must learn to navigate. Several and low-cost innovations are aimed at rural residents. These include the one-laptop-per-child initiative and services such as 1-cent-per-minute phone calls, mobile banking, off-grid electricity, or microfinance [31]. Opportunities for enrichment (see chapter 6 on creativity training) could be a prominent goal for disadvantaged populations.

Nevertheless the implication that the poor have fewer avenues to creativity may be qualified. The 2012 PISA scores on creativity showed a smaller penalty for lower socioeconomic status students than expected. Poorer students may have to exercise problem-solving skills after school. And vocational school attendance in some countries seems related to better problem-solving skills. However, school quality matters. Disadvantaged students score below the better-off in all topics related to problem-solving (OECD, 2012).

“ Life in cities exposes children to multiple unexpected events that they must learn to navigate. ”

D. A Creativity ‘Theory of Everything’

Clearly, creativity is a complex process: it is influenced by personality characteristics, motivational states, thinking processes, the environment, and the requirements of the needed innovation [200]. The factors that matter are:

- interest and commitment to the task,
- knowledge and technical skills, and
- ability to break mental sets apart and think in divergent ways [9].

These components influence the quality of the results and the time devoted to a certain stage of problem-solving. If we do not know enough or if we have little interest in a particular task, we may spend little time in it and abandon it.

Efforts to combine all the components that affect creativity resulted in a ‘theory of everything’: the investment model of creativity by Robert Sternberg and Todd Lubart [238]. According to them, there is a confluence of six distinct but interrelated resources: intellectual abilities, knowledge, thinking style, personality, motivation and environment (see below Figure 11).

Thus the creative process is incredibly complex. Besides thinking skills, it involves intelligence, personality traits, and environmental influences (subsequent sections of this document discuss these in greater detail).

But creativity is not merely the arithmetical sum of these factors: the confluence, compensation and integration among them are vital. People act differently in different situations, according to the levels in which they express various traits. And most of these can be modified and developed [181]. Therefore, creativity appears as a trainable competence that can flourish in educational institutions.

Figure 11. The investment model of creativity of Sternberg & Lubart (1991).

Six resources (R, above) converge in an interactive manner to generate various domain-relevant creative abilities (C). These abilities are partially overlapping. Each ability can generate creative actions and a portfolio of creative projects (P).

These projects yield products that can be in turn evaluated (E). We can measure creativity only through these evaluations. However, evaluations can be influenced by the evaluator and by the spatiotemporal context in which the evaluation is performed.

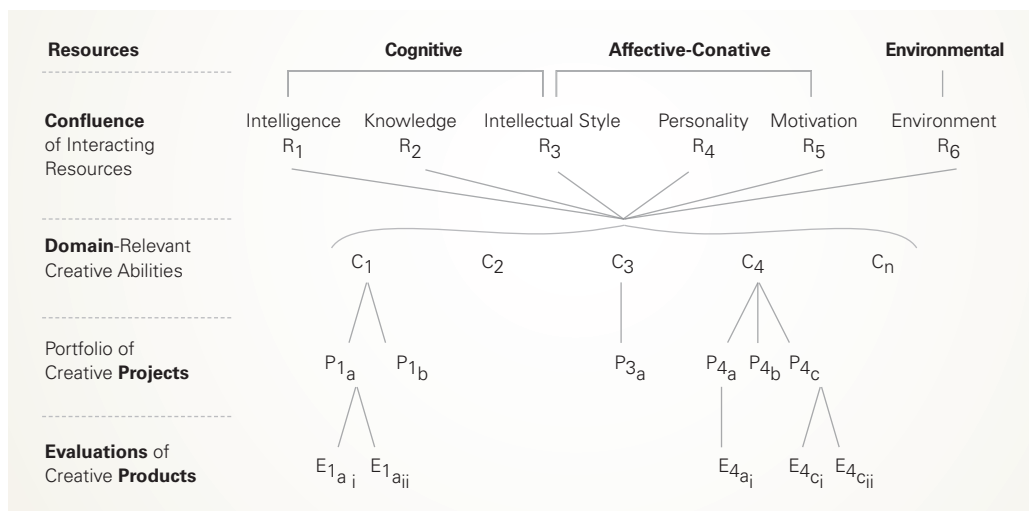

E. Creativity for All: A Scale of Graded Cs

The good news from the research is that we all have creativity. A current model developed by Kaufman and Beghetto [133] posits four levels: mini-c, little-c, Pro-c, and Big-C (see Figures 12 and 13). It distinguishes the creativity that emerges in all people from that of the rare outliers. It thus facilitates studies to examine the more intrapersonal and developmental aspects of creativity.

Little-c is considered everyday creativity [202, 203]. It includes tasks like finding a new combination of ingredients to prepare a tasteful dish, or to decorate a house. Little-c creativity emerges as a result of information processing mechanisms, personal knowledge, experiences and their personal interpretations, and the sociocultural context [208, 209, 179, 24, 49, 214, 263].

Mini-c is a subcategory of little-c and refers to the novel and personally meaningful interpretation of experiences. These are involved in the construction of personal knowledge and understanding [23]. One example would be a child learning to write a song or inventing rules of play [49, 208].

The Pro-c refers to the expert-level, professional creativity. It could refer to a popular novelist or a composer whose work is currently popular or an expert physicist. Pro-c creative acts can change an entire field of knowledge (Propulsion Theory of Creative Contributions developed by Sternberg and colleagues [242]). They may present different perspectives in a domain,* take a big step forward, or make a contribution that pushes the domain a great deal further and in a new direction. Pro-c people may be ‘disruptors’ and replace the current paradigm [133]. One such example may be Grace Hopper (1960-1992), a pioneer in computer languages like COBOL.

Big-C usually involves formal training and a substantial amount of time before it is expressed. It is considered as the outcome of a clear-cut, eminent creative contribution [224]. Examples would be Ramanujan, Albert Einstein, Michelangelo, Leonardo da Vinci. This form of creativity is sometimes considered a gift that can only be expressed after enormous sacrifice [87].

Figure 12.
The Complete Four-C Model. Adapted from Kaufman, J. C., & Beghetto, R. A. (2009): *Beyond Big and Little: The Four C Model of Creativity*.

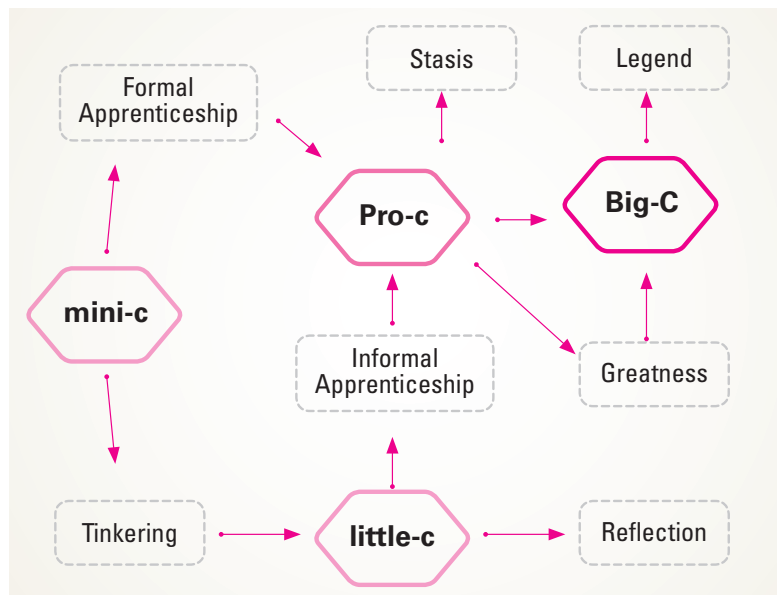



Figure 13. Examples of the four creativity levels described in Beghetto & Kaufman’s model [23].

The model also suggests that the lower levels of creativity are very valuable and have particular relevance for education.

Creativity can be taught and does not require genius; it simply requires the ability to transform and reorganize incoming information on the basis of a student’s characteristics and previous knowledge. Indeed, the construct of mini-c emphasizes the need to recognize the creativity inherent in students’ insights and interpretations. Since mini-c experiences often happen during the very first years of life, such moments should also be encouraged by teachers and parents in order to nurture innate creativity. By contrast, an excessive focus on Big-C may lead to false but widely spread beliefs that that only certain people can be creative or that only important discoveries matter.

Finally, the propensity for practice leading to Pro-c creativity may be inherited. One example is high levels of skill and creativity among musicians who practiced about 10,000 hours as children. Studies of twins have shown that the propensity to practice was between 40 and 70 percent heritable and that there was no difference in musical ability between twins with varying amounts of cumulative practice [362]. Such levels of practice and dedication may lead to Pro-c creativity. However, there is a difference between technical proficiency and creativity or artistic worth. Accomplished virtuosos may be lacking creative expressions of less accomplished pop musicians who resonate with people. Both creativity and expertise may be influenced by genes, but by different genes [305].

It could also depend on the interaction among the domain,* the person, and the context (Csikszentmihalyi’s 1999 Systems Model of Creativity).

The 4-C model has considerable utility. It is a framework for conceptualizing and classifying various levels of creative expression. The implication is that nearly anyone can experience all aspects of creativity, with the exception of the Big-C, which is considered a gift reserved for the few. Thus it points to potential paths of creative maturation [133]. Its stages can potentially represent a developmental trajectory in a person’s life, although such full progression is extremely rare.

F. Creativity Changes Through the Lifespan

There is potential for creativity at any time in life. Children's mini-c may be unleashed through play. Although it is assumed to be beneficial, long-term effects of specific activities have unclear effects. For example, a review of pretend-play showed uncertain outcomes [151]. This implies that creativity is not necessarily promoted through commonsense activities.

Certain normal changes associated with aging could potentially reduce creativity. These include distractibility and reduced working memory* capacity that may reduce the mental resources available for finding creative solutions.

However, people who have engaged in such work for the long term may be less affected [57, 225]. Factors like physical condition and education are protective through the life span. Professionals often display a qualitative and quantitative resurgence of creativity in their final years [226]. People who acquired artistic skills early in life and continue to use them may obtain multiple benefits in old age [365].

Several studies have shown that regular exercise helps maintain memory functions in older people; a substance called brain-derived neurotrophic factor strengthens old synapses and causes new ones to grow [73]. Not surprisingly, exercise has been shown to promote creativity [52]. The reasons may include the physical condition of the brain but also experience in changing responses rapidly according to the demands of the sport.

"We had a group of super-intelligent girls who sat there for 40 minutes really mulling it [a creative essay] over and one of the boys just said to them "er...why don't you do the title 'the day I went mad with a spade'?" That's it, they said and they started writing..." in Howard-Jones, P. A. (2008): Fostering creative thinking: co-constructed insights from neuroscience and education.

G. Gender and Creativity

Are there differences in creativity related to gender? The answers are complex.

The cortical activity of men and women may differ when producing more vs. fewer original ideas [77]. In original responses, females with higher verbal IQ showed a stronger response in frontal cortex than verbally average intelligent females, while in males just the opposite was found. This effect was more pronounced when the participants' task was to generate as many original consequences to given utopian situations. One study showed that adult males did better than females in the creative performance of collage-making [255]; however, from a technical perspective, there was no difference between the two groups.

Several other studies have found substantial sex differences in brain connectivity, suggesting that differential connectivity patterns may account for cognitive differences [98, 99, 121]. Ryman et al (2014) have recently studied the relationship between the structural organization of the human brain and creativity by the means of divergent thinking tasks. The authors' results highlighted that while females demonstrated significant inverse relationships between global connectivity and creative cognition, there were no significant relationships

observed in males. Their results seem to suggest that in females more regions of the brain are involved when producing novel ideas while males, in contrast, exhibited few, relatively weak positive relationships across measures like connectivity, efficiency, clustering and creative cognition.

However, results seem to be task-dependent: behavioral performance on the alternate uses task revealed that men and women were undifferentiated in terms of the degree of originality, the degree of fluency or the number of uses generated. It is still worth keeping in mind that, despite similar behavioral results, fMRI images indicated that different brain areas were involved by the two genders, confirming at least a difference in the strategy used when performing the same task [1]. Specifically, brain areas related to semantic cognition, rule learning, decision making, divergent thinking and declarative memory were preferentially engaged in men, whereas women displayed higher activity in regions related to speech processing, social perception, theory of mind and self-referential processing [1].

One piece of evidence regarding the role of gender in finding creative solutions to problems comes from the 2012 PISA tests (OECD, 2014). Boys outperformed girls in problem-solving in 23 countries, girls outperformed in 5, and in 16 countries there was no significant difference.



“Do I have to be creative?”

“ Girls appeared to be stronger in the planning and executing tasks and weaker in the more abstract ‘representing and formulating’ tasks. ”

Gender differences are often most visible at the top. On average, among OECD countries, there were three boys for every two girls in problem-solving. In no country or economy were there more girls than boys among top performers in problem-solving. In Croatia, Italy, and the Slovak Republic, boys were just as likely to be low achievers, but they were more than twice as likely to be top performers as girls. Girls appeared to be stronger in the planning and executing tasks that measure how students use knowledge; they were weaker in the more abstract ‘representing and formulating’ tasks, which relate to how students acquire knowledge.

Differences in creativity notwithstanding, many creative women face certain difficulties at school or work. There is often a societal pressure on women to conform, so confident divergent thinkers may not be well-received [95]. Women are also expected to have better social skills than men and are penalized when they do not [194]; this may distinctly disadvantage creative women with schizoid traits who may have limited communication skills.

One British study suggested that women at work are often very creative, but they face constraints. Men tend to coalesce and work creatively as a team when faced with competition. By contrast, when faced with competition, women become less creative, particularly when competing against other women [16]. One reason may be avoidance of escalating conflicts among women at work [363].



THE NEUROSCIENCE OF CREATIVITY: ESSENTIAL CONCEPTS

Multiple regions and functions in the brain are involved in creativity. This section offers the essential concepts that may help the reader better understand the research and its implications.

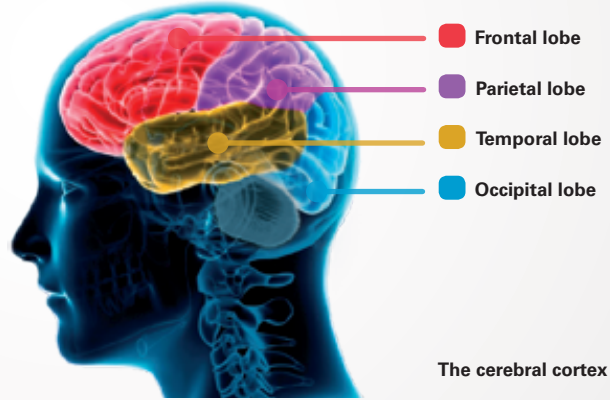

The cerebral cortex

How is information obtained directly from the brain?

Various technologies have helped map the structures of the brain and connect information on what these do. They include fMRI (functional magnetic resonance imaging), PET (positron emission tomography), electro-encephalography (EEG) that records event-related potentials (ERP), and NIRS (near-infrared spectroscopy). Each method has various advantages and disadvantages.

fMRI does not depict changes across time well, but it shows the selected parts of the brain in great details (Figure A, left). Electro-encephalography is a non-invasive measure of electrical brain activity that records events as they happen in time much better. It shows voltage changes between different points on the scalp, which arise primarily from neuronal activity. When participants see external stimuli, the recorded responses are called event-related potentials. This information helps connect brain structures and cognitive processes going on over time (Figure A, right).

Figure A. Brain-imaging equipment.

Left: a scanner for fMRI.
Right: a cap used for electro-encephalography.

Main areas and functions of the brain involved in creativity

Human brains have the same general structure as the brains of other mammals, but have a more developed cortex than any other. The cerebral cortex is a thick layer on top of the brain. It mainly consists of neurons. Neurons are cells that process and transmit information through electrical and chemical signals.

The entire brain is always active, but to carry out various tasks, some areas connect to others, as needed. Thus complex pursuits, whether creative or technical, involve numerous communicating regions from all over the brain. Therefore the view that some functions take place in the right or left brain, or the view that some people are analytical and others are creative, is outdated.

Anatomically, the cortex is divided into four 'lobes': The frontal lobe, parietal lobe, temporal lobe, and occipital lobe. The occipital lobe is related mainly to vision, and the other lobes support multiple activities. Working memory* functions are primarily represented into the temporal lobe, while executive functions* rely on the activity of the frontal lobes.

Many areas are activated when participants carry out creative thinking. They include the frontal lobes, where working memory* and executive functions* are involved. Divergent thinking,* insightful problem-solving, and artistic tasks tend to activate the prefrontal regions of the cortex. These are involved in planning complex cognitive behavior, personality expression, decision making, and moderating social behavior [41, 306, 78, 307, 308, 97,

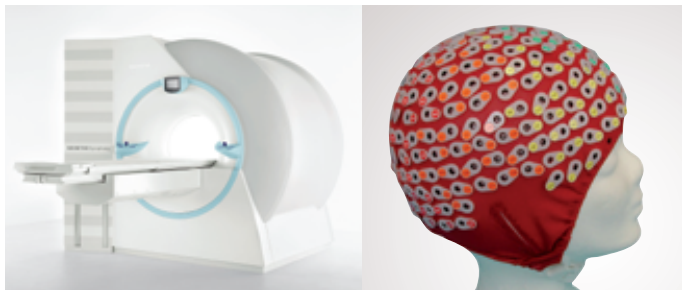

309, 310, 117, 311, 12, 22, 312, 313, 314, 315, 316, 317, 318]. One area below the cortex, the hippocampus, is mainly involved in memory formation and is activated when creative connections are learned [316, 317].

Brain structures associated with logical reasoning are inversely correlated with creativity [150]. These are located in the posterior brain (the left lateral orbitofrontal gyrus, lingual gyrus, inferior parietal gyrus, and fusiform gyrus). There has been an erroneous view that creative tasks take place in the brain's right hemisphere. Figuratively speaking, one could consider the creative undertakings as the 'front brain', and more analytical or visual undertakings as the 'back brain.'

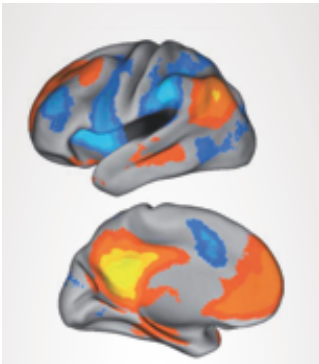

Figure B. The brain's Default Network vis-à-vis Executive Attention Network. Adapted from Buckner et al (2008): *The Year in Cognitive Neuroscience*.

Intrinsic activity suggests that the default network is negatively correlated (anticorrelated) with brain systems that are used for focused external visual attention. Anticorrelated networks are displayed by plotting those regions that negatively correlate with the default network (shown in blue) in addition to those that positively correlate (shown in orange).

Creativity and the resting-state default network

In recent years, neuroscientists have identified two opposed brain networks: the default mode network* and the executive attention network* [319]. The former is involved when we are engaged in internally focused tasks such as recalling deeply personal memories, daydreaming, sleeping, imagining the future, and trying to take the perspective of others. The latter is thought to be involved when our attention is directed outward, and we must exert control over our limited attentional resources. The two are 'anticorrelated,' that is when one is active (blue in Figure B) the other is deactivated (orange in Figure B). When our working memory* brain network re-engages, our default brain network* recedes into the background.

People with higher default network activity during rest have a tendency to daydream more frequently. The brain regions involved in this task are the precuneus* and the nucleus accumbens*. The precuneus* is a part of the superior parietal lobe forward of the occipital lobe called the nucleus accumbens*. This part of the brain moderates a person's ability to filter out irrelevant stimuli. This filtering function is called lateral inhibition*. Reduced lateral inhibition* might enhance divergent thinking by widening (or loosening) the associative network [122]. This facilitates connection of concepts that are normally remote in a person's knowledge network.

“

There has been an erroneous view that creative tasks take place in the brain's right hemisphere. Figuratively speaking, one could consider the creative undertakings as the 'front brain', and more analytical or visual undertakings as the 'back brain'.”

Moods and Neurotransmitters

The brain is made up of neurons that pass electrical currents from one to the next. Between each neuron is an extremely small gap called a synapse. Neurons pass an electrical signal to the next neuron by releasing chemicals that are called neurotransmitters into the gap. These decrease or increase the electrical activity of the receiving neuron. Acetylcholine, dopamine,* and serotonin* are such chemicals. Dopamine* is often tagged as the 'reward' chemical, because it is released in the 'reward pathway'. It may bring feelings of joy and self-confidence. Serotonin* is often involved in appetite and mood. It is linked to tranquility, reason, and calmness. Serotonin* and dopamine* are extremely important in creative thinking since researchers have shown that to be creative it is necessary to be both relaxed (but not too much) and, at the same time, have a certain level of mood activation which is provided by neurotransmitters such as serotonin.*



Creativity and Neuroscience: Glimpses into Idea Generation

A. The Revelations of Cognitive Neuroscience

As neuroscience matured, various neuroimaging instruments became available and made it possible to assess creativity states in the brain. Studies have been conducted to determine how brains function during creative versus non-creative thought [104, 143, 212] or to differentiate highly creative people from less creative people [10]. It is possible to distinguish the generation of new, creative ideas from that of old, more common ideas [117].

In the previous chapter, issues and questions about the meaning of various test conditions and findings were discussed [3]. But over time findings became more interpretable. Consistent patterns of neural activation do emerge when the cognitive process and the neuroimaging method are kept uniform across studies [262].

If Einstein or Ramanujan were alive today, their brains might be scanned while doing various tasks or just sitting quietly. It might then be possible to locate the structural and functional connections that made their thinking so different from that of other people.

This section discusses some of the findings and their implications.

Neuroimaging studies systematically indicate that the areas involved in the production of creative solutions are the prefrontal regions, known to be involved in working memory* and executive attention*. This finding validates the studies showing that consistent production of creative ideas depends on these executive functions [21]. Similarly, the brain mechanisms and the cognitive processes operating at the basis of divergent thinking* are related to focused, internally directed attention and involve retrieval and selection of semantic concepts [27].

Another study investigated regions of activation involved in conceptual expansion*, as distinct from general divergent thinking,* working memory,* or cognitive load. The regions involved are those also involved in the retention, retrieval and integration of conceptual knowledge. The right hemisphere is not dominant during creative thinking [4].

A popular misconception exists that creativity is a function of the right brain. A review of 14 neuroimaging studies indicated that creativity is not lateralized for either cerebral hemisphere [66]. However, there are some exceptions. For example, insights on solving verbal problems depend on a neural pathway on the right side of the brain [280]. But the brain switches tasks constantly, so effects are averaged out.

B. Eminent Creativity: Daydreaming While Focused on a Task?

What makes a few people much more creative than others? Neuroscientific research has some preliminary answers.

People with a more active default network* during rest have a tendency to daydream more frequently. During concentration, the brain shuts out distractions, such as music. However, this filtering mechanism, called lateral inhibition,* does not work well among some creative people. As a result, they daydream more, even while concentrating [43]. In one study of highly intelligent individuals, highly creative achievers were seven times more likely to have reduced lateral inhibition.* In fact, the more creative the participants, the more difficulties they had in suppressing irrelevant stimuli while engaging in an effortful working memory task. This mechanism is mediated by the precuneus,* an area of the default mode network* that has been linked to self-consciousness, self-related mental representations, and the retrieval of personal memories [246]. Creative performance is also linked to the gray matter volume of the default mode network,* and this offers additional evidence that mechanisms related to it, such as the precuneus* activity, are important in creativity [144].

Of course, creativity does not come from only one source. Highly intelligent people are also able to activate their knowledge store rapidly and use executive functions* efficiently. If they also have a more active default network* during rest, they have easier access to ideas that are stored in different parts of their network and may come up with more and more unusual combinations. This is perhaps how eminent creativity is obtained.



Daydreaming while focused

To suppress irrelevant stimuli, the dopamine neurotransmitter* is important. However, certain neurons that need it to function are compromised in schizophrenia, depression, and also in Parkinson's disease. This is one reason why some of the same processes that produce unusual associations and thoughts are also involved in mental illness.

Active schizophrenics are not necessarily creative; they are often too disabled to develop useful products that meet the standards of creativity [3]. However, certain individuals who have what could be described as mild 'schizoid' traits,* can show unusual creativity. They are often eccentric people with vivid imaginations and have enhanced social-emotional creativity [320, 321]. In one study, the more schizoid group proved to be better than people without these traits at overcoming the constraining influence of examples when trying to generate original responses [3]. On insight problems, individuals with more schizoid traits also performed better than individuals without such traits. But they did worse on incremental problems that required focused goal-related thinking [132].

Neuroimaging offers a glimpse of how these processes function. Studies of individuals who belonged to families that have significant creativity as well as mental illness showed smooth brain activation (See Figure 14). The images on the left show brain activation while the subjects alternate between an experimental task (word association) and a control task (reading a word). The line representing the creative subject's brain activation (upper graph) moves smoothly up and down as the task changes, reflecting effective use of the association cortices in making connections. The control subject's activation line (lower graph) looks ragged by comparison [10].

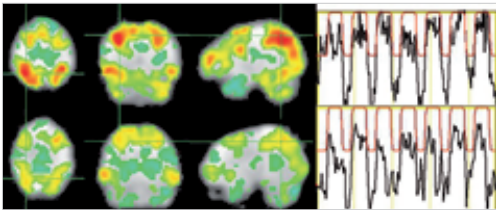

Figure 14: The images on the left show the brain of a creative subject (top) and a matched control subject (below) during a word association task. Adapted with the permission of Dr. Nancy C. Andreasen.⁶

One unexpected outcome of dopamine's* role in creativity has come from Parkinson's disease research. Patients given levodopa and similar drugs may display unusual creativity, particularly in art [122, 46, 215, 145, 218, 264, 271, 32]. Lowering the dosage or using deep brain stimulation reduces creativity [74, 149]. It seems that the action of dopaminergic agents in reducing lateral inhibition* widens the associative network and enriches divergent thinking.* However, the findings about Parkinson's disease do not mean that people will become more creative if given dopaminergic drugs. Perhaps disease must be present for these drug effects to occur.

A similar outcome may be obtained through certain meditation methods. Those who practiced open-monitoring meditation (i.e. allowing thoughts to come in and monitor them) showed more creative thinking. This may happen due to the default network* activation during meditation. By contrast, meditators who focused their attention (i.e. concentrating on a sound or image) did not show obvious signs of improvements in a task involving generating new ideas after a meditation session [50].

C. Why Fatigue and Distraction May Bring Creative Ideas

Most people are not highly creative geniuses. Everyone, however, has some opportunities to use the advantages of the default network.* This may happen when people are tired or distracted. Additionally, taking a shower or going for long walks⁷ may provide opportunities to connect concepts in the mind that do not easily come together.

Both common sense and research suggest that for analytical work like problem-solving, answering questions and making decisions, the best moment of the day is the morning, while the brain is 'fresh'. However more creative ideas arise when the brain is tired. 'Night owls' solved the insight problems better in the morning, whereas the 'morning larks' solved the insight problems better at night. On the other hand, the time of day did not affect the students' ability to solve analytical problems [269]. It seems that tasks involving creativity might benefit from a non-optimal time of day, when the brain is tired and more susceptible to irrelevant information. The opportunity of an incubation period may also account for the effect [227].



"We like to bring together people from radically different fields and wait for the friction to produce heat, light and magic. Sometimes, it takes a while."

Interestingly, increasing the sense of distance between people and a problem they are trying to solve may put people at ease and thus make them more relaxed [128]. For example, pretending that the problem belongs to someone else may help [197].

Overall, to maximize creativity, a 'yin and yang' of pressure and relaxation may help. There must be a problem that requires solution, preferably by a specific deadline. Potential solvers must relax and take time off in order to solve it.

One important implication for schools and firms focused on the production of innovative ideas is to somehow accommodate the off-time necessary for the default mode network* to function and for associations to be made. Requiring solutions in a short time frame or under pressure may not get the best results, unless highly creative people are involved.

D. The Effects of Various Substances on Creativity

Aside from Parkinson's disease drugs, are other substances linked to increased creativity? Research shows limited effects of certain frequently used substances. Caffeine increases attention and reaction speed. This might be helpful if solutions require speed and alertness, but improvements in creative thinking have not been measured [94]. Despite various claims about the benefits of cannabis, a study found that consumption had no effect on occasional users and reduced the incidence of divergent thinking among habitual users [35]. The effects of tobacco have not been studied extensively; nicotine may have short-term cognitive benefits, but long-term harm outweighs them [206]. Therefore, the creativity potential of various frequently used substances is minimal.

In the 1960s, some creativity experiments were conducted with psychedelic drugs that subsequently became illegal [30, 279, 222, 44]. Results were ambivalent, partly because people under such states have little control of their actions. It is conceivable that safer and reliable drugs will be developed in the future that may permit people to access the connections of their default network* while engaged in problem-solving.

“ One important implication for schools and firms focused on the production of innovative ideas is to somehow accommodate the off-time necessary for the default mode network to function and for associations to be made. ”

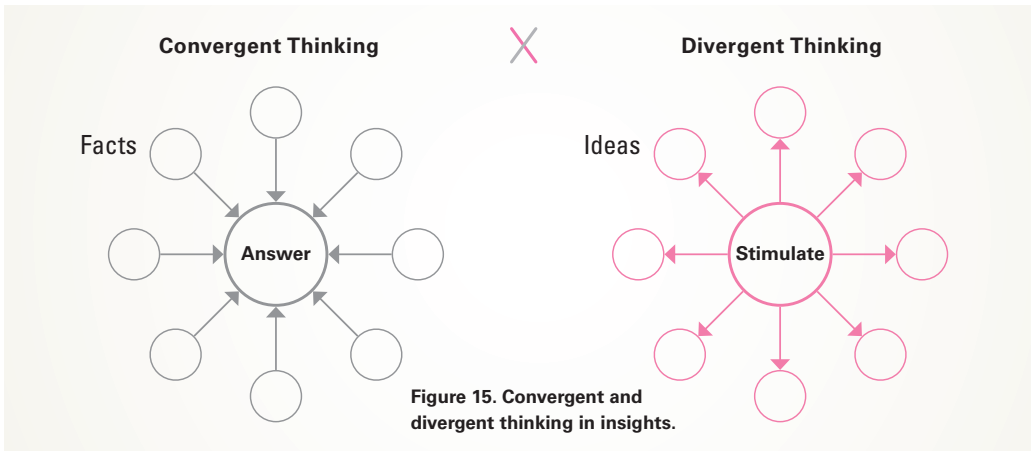

E. The Neuroscience of Insight

Insights are sporadic, unpredictable, short-lived moments of exceptional thinking, where tightly automatized ‘mental sets’ are broken apart into their constituents or reorganized [243, 156]. Insight problem-solving requires convergent and divergent thinking. Convergent thinking* results in a single correct solution, but the problem must be restructured by means of divergent thinking* [3]. The early models of creativity stages (preparation, incubation, illumination and verification) considered the first three stages as the direct outcome of an intuitive process [20].

Studies investigating insight highlighted the role played by the anterior cingulate cortex [12, 22, 142, 157, 229]. This region appears to be important in detecting cognitive conflict and initiating processes that lead to the breaking of the mental mind-set that keeps a person stuck in the wrong solution space.

Unlike other creativity processes, insight can sometimes be visibly observed. During problem-solving, the brain tries to maximize attention and limits visual interference. This creates a clear correspondence between the eye movement pattern and the cognitive process during the problem-solving task.

Eye tracking can record eye movements during problem-solving and the ‘aha!’ moment, when the solution unexpectedly comes to mind [100, 139, 213, 36, 141].

While participants are looking for a solution but unable to find it, eyes are fixed on a single spot: the fixations are few and last longer periods. Being stuck is reflected in more eye movement fixations on some elements of the problem in the early stages of the tasks. And when the solution is found, participants move their eye towards new places. People who fail to find the solution do not move their eyes to new positions [139]. When people reach the solution through insight, they blink more, produce fixations of a shorter duration, and tend to look away from the problem. Closing the eyes may increase the chance of a successful outcome. One reason may be linkages to the default mode network* of the brain. This phenomenon provides an observable clue about creative processes, and it could potentially be used as a means of assessment.

These phenomena suggest that the anterior cingulate cortex may mediate processes of breaking one’s mental set. It is involved in the control of cognitive processes, such

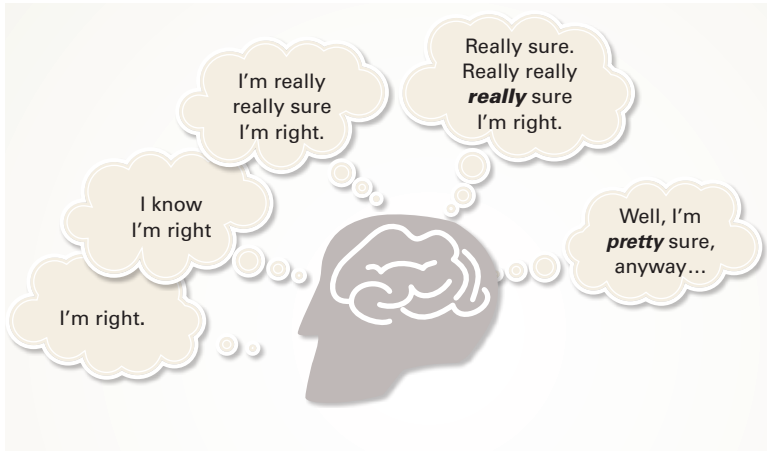

Figure 16: Insight generates good ideas, but validity is sometimes uncertain. Adapted with permission of Julie Dirksen, usablelearning.com

as detection of inconsistent or competing activity, or attention switching [34]. Conversely, when the problem is solved analytically, there is more neural activity measured in the posterior cortex, an area mainly involved in visual functions.

The early period of insight solution shows more activation in the areas associated with extensive semantic processing, as well as detecting and resolving cognitive conflicts. Towards the end, the hippocampus and the amygdala become activated, perhaps because the new findings become connected to the ‘aha!’ feeling. The hippocampus has a crucial role in learning, and activation suggests that the new associations may be reused in the future [280].



F. Some Conclusions from Neuroscience

Overall, neuroscientific studies have clarified when and how states appear in the brain that are labeled as creativity. The research has helped bring together the memory functions necessary to search the cognitive network quickly and the daydreaming states that often characterize eminent creativity and related schizoid* traits. This integration explains why relaxation may help ordinary people find creative solutions.

One implication of the research is that some aspects of creativity may indeed be generalized over all domains. However, thinking about esthetics vs. math often activates different regions in the brain. Training that affects one region may not affect another. Therefore, creativity training is more likely to improve performance in specific domains* rather than in all. For example, learning solutions for math may not help students mix colors for art projects. Nevertheless, the efficiency of training may improve in the coming years with broader applications of neuroimaging as feedback for training content.

4

EXPLORATIONS
OF CREATIVITY

Moods and Personality Variables

Many studies have explored the role of these variables on creativity. This section presents the highlights and overall findings.

A. How Mood, Perseverance and Persistence Influence Creativity

Some people are buoyed by encouragement and optimism, while others perform their best when in a dark mood. For example, Mozart composed the famous Requiem Mass in 1791 while very ill and probably in a dark mood.

Mood is one of the most widely studied variables related to creativity [11, 90, 123, 173]. But how is mood associated with this process? As with everything else pertaining to creativity, the story is complex.

Positive moods are often believed to increase cognitive flexibility [48, 216, 11]. According to the cognitive tuning model, a positive affective state may lead individuals to experience their situation as safe and problem free, feel relatively unconstrained, take risks, and explore novel pathways and new possibilities in a relatively loose way, relying on heuristic processing styles

[76, 91, 217]. People in a positive mood may easily access their knowledge store, and these easy associations may lead to greater flexibility and originality [158]. Positive instructions and words may also increase verbal creativity, especially the originality of the responses. Conversely, a negative tone may obstruct verbal creativity [162].

“Mood impacts creativity in ways that are complex and harder to predict.”

Figure 18. The roles of activation and tone in the dual pathway to creativity.

Adapted from De Dreu et al. (2008): Hedonic tone and activation level in the mood-creativity link: toward a dual pathway to creativity model.

However, mood impacts creativity in ways that are complex and harder to predict. Indeed, some studies suggest an advantage of positive over negative moods [101, 113, 114], but others suggest increased creativity for negative moods [40, 88, 135, 160]. Other studies suggest a similar influence of moods on creativity levels [322].

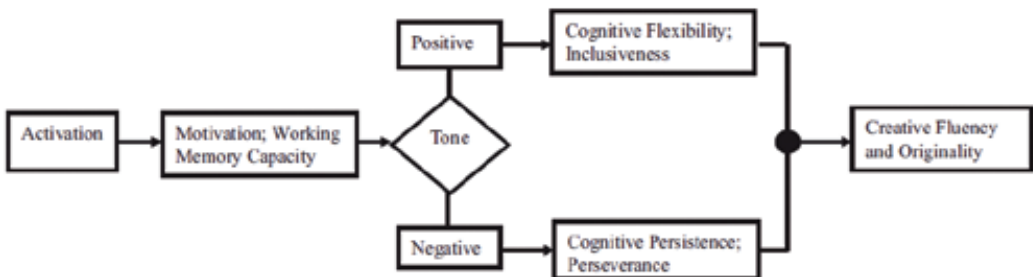

The ambiguous findings suggest that other variables moderate the relationship. One of them is how active people become under various moods (Figure 18) [323]. Moods such as happiness, joy, anger, sadness, or depression may make different people more or less willing to act. This may depend on perseverance* and persistence* [323, 18, 102, 105, 198, 247, 268]. Therefore, each mood can be classified as:

- Positive in tone and deactivating (e.g., calm, relaxed)
- Positive in tone and activating (happy, elated)
- Negative in tone and deactivating (sad, depressed)
- Negative in tone and activating (angry, fearful)

Activating moods increase the capacity to perceive, process and evaluate multiple alternatives and also integrate past and present information [38, 42, 231, 273]. Deactivating moods reduce these processes.

Under what circumstances are people more or less likely to persevere and find creative solutions to various problems?

The arousal level in the brain helps release neurotransmitters such as dopamine,* noradrenaline, and serotonin.* These neurotransmitters enhance working memory functions [80, 177, 259]. Working memory* holds information temporarily, so that it can be manipulated and employed in further reasoning. Moderate dopamine* levels facilitate efficient processing of task-relevant information [69], help maintain it longer in memory [51], and facilitate switching between tasks [70]. Moderate levels of noradrenalin also enhance prefrontal cortex control of behavior, including working memory* [205, 259], and sustain attention on task-relevant information [324]. If the levels of these neurotransmitters are too high or too low, the result may be inactivity.

“ It is commonly believed that creativity is best nurtured in a supportive, trusting environment conducive to self-actualization. ”

The amounts of neurotransmitters that exist in various neurons at any time are highly variable. But different people also tend to have relatively steady states of various neurotransmitters in their brains.

The impact of mood on divergent thinking may depend on a given individual's steady dopamine* level. This has been tested in a study by Akbari, Chermahini and Hommel [6] detailed in appendix 3.

It is commonly believed that creativity is best nurtured in a supportive, trusting environment conducive to self-actualization. However, the research suggests that this works only for certain people. Furthermore, it is questionable whether creativity would blossom in an atmosphere free of pressure. Very simplistically, those who have overall lower levels of dopamine* may show limited activity in an atmosphere of positive mood, while those with overall higher levels of dopamine may persevere regardless of their mood. For example, the mathematician Ramanujan sustained activity and showed impressive perseverance* in contacting famous mathematicians, attending to mathematics terminology in English, and organizing his work so that it would be understood by others.

One conclusion from this complex set of studies is to avoid overgeneralizations. It is useful to set goals, maintain well-timed expectations for deliverables, and perhaps avoid situations that may create mood extremes.

B. The Personality Traits of Creative Individuals

People's personality traits result from complex interactions between biological variables (such as levels of neurotransmitters) and personal situations. Biology makes some traits relatively stable in life, though all are subject to change. Personality was an important concept in the 20th century. Thousands of studies were undertaken, using observations and validated questionnaires. The somewhat vague and changeable status of personality has limited the utility of this concept for personal attributions. There is some utility, however, in using personality traits for populations.

The relationship between creativity and personality traits has been studied extensively. Traits like self-efficacy, the willingness to overcome obstacles, take sensible risks, and tolerate ambiguity are important, as also suggested by studies on mood activation and dopamine levels [152, 238, 240]. Creative people may be more autonomous, introverted, open to new experiences, norm-doubting, self-confident, and self-accepting. They may have drive and ambition, they may be dominant, hostile, and impulsive. Conversely, traits like conscientiousness, conventionality and closed-mindedness were negatively related to overall creativity levels [75, 272].

Openness to experience seems to be the important personality axis related to divergent thinking. It is defined as the willingness to try out new ideas, explore and be curious about one's inner ideas and the outside world [54, 165].

“ Creative people may be more autonomous, introverted, open to new experiences, norm-doubting, self-confident, and self-accepting. ”

In the 21st century, the most influential theory of personality is embodied in the Five Factor model. The model suggests that people can be classified along five axes: openness,

conscientiousness, extraversion, agreeableness, and neuroticism (OCEAN) [75]. Predictions about behavior can be made on this basis.

People who engage in everyday forms of creativity - such as making a collage, taking photographs, or publishing in a literary magazine - tend to be more open-minded, curious, persistent, positive, energetic, and intrinsically motivated by their activity.

Those scoring high in everyday creativity also reported feeling a greater sense of well-being and personal growth compared to their classmates who engaged less in everyday creative behaviors [125].

Other studies showed a significant position correlation between extraversion and divergent thinking [165, 221, 230], as well as between extraversion and verbal creativity [138].

Agreeableness, another cardinal personality dimension, seems to have an unclear relation to creativity. A creative person can have a less agreeable and more independent perspective [109], but agreeableness and divergent thinking are not necessarily related [138, 165].

Personality assessment combined with neuroimaging has somewhat clarified the role of various traits [150]. Creative individuals had higher gray matter volume in the right posterior middle temporal gyrus (pMTG). This might be related to novel associations, conceptual integration and understanding of metaphors. Openness to experience, extroversion, conscientiousness and

agreeableness contributed to creativity, but only openness to experience mediated the association between the right pMTG volume and trait creativity. Therefore openness to experience seems to play a central role in shaping an individual's penchant for creativity.

The creativity connections of various personality traits led to a hypothesis that there are thinking 'styles' which resemble the three branches of government: legislative, executive and judicial [235]. People with a legislative thinking style reportedly prefer to play with their own ideas, do things their own way and come up with their own strategies for solving problems. Conversely, the executive style is characterized by a preference for following instructions, implementing others' ideas, and having clearly defined roles. People with a judicial thinking style prefer to analyze, evaluate, and critique others' ideas [240].

The thinking style could interact with test instructions [181]. The legislative thinking style showed higher creative performance, whereas people who preferred to analyze and evaluate ideas (i.e., those with a judicial thinking style) showed lower creative performance when not given any special instructions [181]. Subsequent research suggests that thinking 'styles' do not really exist, and that particular uses of information processing mechanisms give this impression.

C. The Dark Side of Creativity: Some Side Effects?

Low scores on the conscientiousness personality trait suggest that creative people may not necessarily be the most responsible or constructive people. In fact, there seems to be a link between creativity and dishonesty.

“ Openness to experience seems to play a central role in shaping an individual's penchant for creativity. ”

In one study, participants who were primed to think more creatively behaved dishonestly more often than individuals who did not get such priming. And the more creative subjects were more influenced by the experimental priming [328]. The above study is not unique. Creativity has been linked to rule bending, law breaking, and social unrest [240, 325]. It has been linked to aggression [326], group conflict [327], and dishonesty [328]. Creative people may feel entitled to special treatment and can generate multiple reasons why certain actions could be ethically justified.

As mentioned earlier, some people have schizoid personality traits* that create interpersonal difficulties. Thus creative individuals are more likely to be viewed as aloof, arrogant, competitive, hostile, independent, introverted, lacking in warmth, nonconformist, norm-doubting, unconscientious, and unfriendly [329, 330]. They are also more prone to drug and alcohol abuse, as well as suicide [84].

Moreover, destructive events in the past have been frequent. Ancient engineers built architecturally marvelous buildings but also siege engines and chemical weapons, such as 'Greek fire.' Arms races may involve high creativity, but they also harm innocent populations and have in the past destroyed civilizations.

Thus creativity has a dark side. Expression to a large degree has certain costs, both to the individual and to society [84]. More extensive analysis and innovative solutions are needed in order to manage these costs and promote the positive aspects of creativity in various societies.

Group Processes and the Social Effects on Creativity

A. Creativity and Societal Norms

Most creativity research has focused on individuals. However, group processes may exert powerful forces on individual creativity.

Creative undertakings are subject to cultural expectations. What is creative to one person may be deviant to another. Groups of shared identity may support various group expressions. In fact they may rate ideas belonging to their group as more creative than those of other groups [5]. Shared social identity or lack thereof is important in motivating individuals to rise to particular challenges [110].

Groups may reject certain people; for evolutionary reasons, this is painful, because humans have survived in groups. Therefore rejected people may be anxious and tense; thus their creativity may be limited. However, independently minded people under these circumstances may show increased creativity [67, 137]. Personality studies underline the importance of independent thinking. Independently minded people who are rejected by a group may feel validated. They may also have to find innovative means to deal with the consequences of rejection.

“ Personality studies underline the importance of independent thinking. ”

This line of research emphasizes the effect of social norms on innovative behavior. When people operate as members of a group (either physically through collective action, or psychologically through social identity salience), innovation tends to conform to normative boundaries. The research also suggests a potential for rejecting ideas that are imported and not created by in-group members.

B. Brainstorming, Teamwork, and Creativity

Teamwork has been greatly emphasized worldwide in the hope that innovative products will result from close and coordinated collaboration. How well is this belief supported by research?

Much research has been conducted on the effects of group meetings and brainstorming in promoting creative ideas at the individual level. Brainstorming is a popular technique that gathers ideas spontaneously contributed by its members [186]. During the process, criticism is ruled out, so groups should make no positive or negative comments until the group has finished generating ideas; quantity is wanted, indicating that members should feel free to generate ideas without self-censoring. Freewheeling is welcome, meaning that the group members are encouraged to say whatever comes to mind. These rules enhance the number of ideas the groups generate [188].

The generation of ideas is a cognitive process involving the retrieval of relevant knowledge from long-term memory* and the integration of knowledge in working memory* [174, 178, 266]. In some cases groups may facilitate and enhance performance [278]. Studies, however, have shown that groups appear to generate only about half as many ideas as the total number of ideas generated by individuals brainstorming alone [65, 172, 192]. Other studies have found that groups inhibit the idea generation of individuals [65].

The reasons are multiple. Individuals may feel anxious about others' opinions of their ideas [39]. A heavier cognitive load is created, because individuals must listen and process others' ideas while generating their own [178, 190], so the ideas of others may interfere with an individual's flow of thought [178]. As a result, members of brainstorming groups may converge to the lower levels of group performance [192]. Group dynamics can also result in reduced responsibility due to the feeling of reduced accountability for individual performance [131].



"I'm still not sure HOW it happened. One minute, we were bouncing ideas off each other, and the next thing I knew, we were using furniture instead."

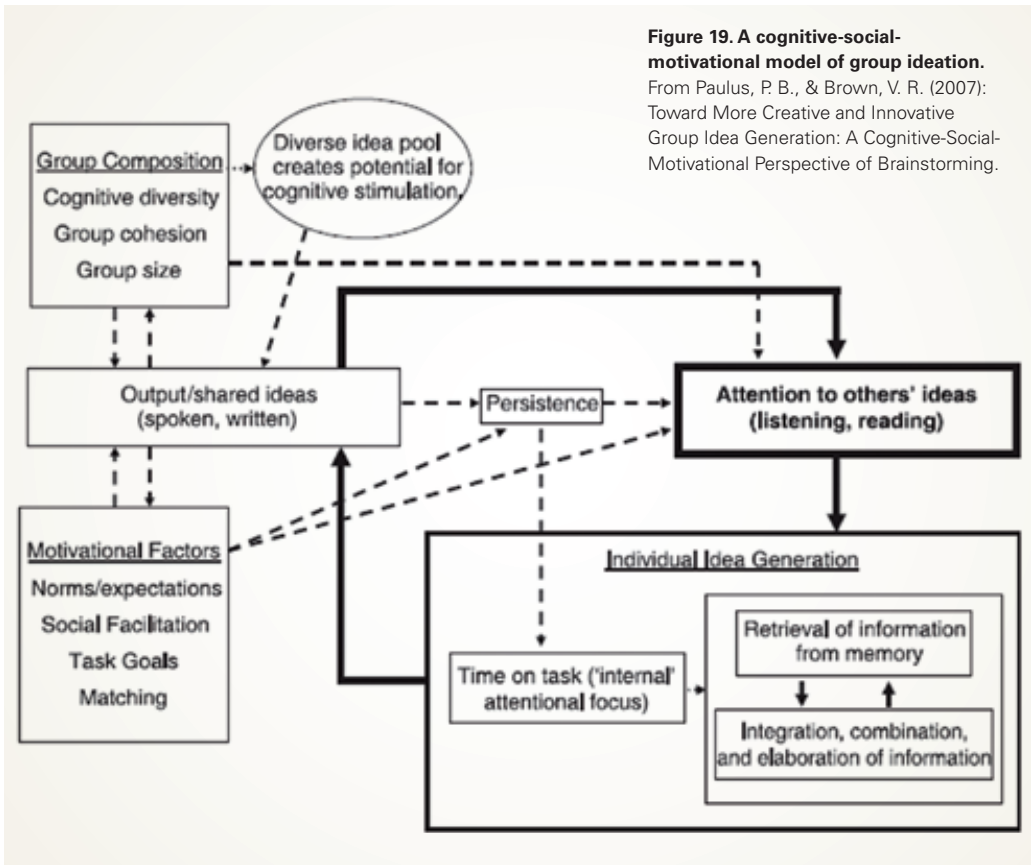

In summary, research on the utility of groups in the generation of creative ideas has had ambivalent results. But what is the source of the discrepancies? Which variables critically determine the influence of groups on creativity?

Social-motivational factors may influence cognitive process. One determinant is attention to an individual's ideas. The probability of being listened to is a function of perseverance,* motivation on behalf of an individual, speed and variability of information retrieval, cognitive diversity in the group (see Figure 19) [191].

Thus, important factors in determining the creativity of group processes include:

- **Motivation:** The sight of all the group members working hard on the task or simply seeing a large number of ideas on the screen may have positive effects [89].
- **Nature and overlap of knowledge** of the group members: groups made up of members with more heterogeneous knowledge are more productive than groups whose members are more homogenous [244].
- **Diversity** in a group is beneficial for idea generation, with respect to knowledge diversity for intellectual tasks; social diversity (ethnicity or age) is not relevant [161]. The role of gender is uncertain.

- **Social effects:** Comparisons with other members can induce a sense of competition and lead to upward movement of performance especially when group members receive feedback about their individual or group performance [53, 193]. When told that others generate a high number of ideas, the number of ideas generated in groups increases [192].

To avoid inhibition and enable brainstormers to express themselves, electronic registration of anonymous ideas may help [65]. This is true only for groups of eight people or more [62, 64].

In summary, the research shows more nuanced outcomes about groups than commonsense beliefs. Effort, persistence, and solid subject-matter knowledge are prerequisites for brilliant ideas [183, 226]. Furthermore, the section on creativity and gender raised issues about women's performance when placed in competitive circumstances [16], given pressure on women to conform. It is possible that groups have differential effects on the creativity of men and women.

C. The Effects of Work 'Climate' on Creativity

Intrinsic motivation is important for carrying out tasks [8]. Personality and mood studies suggest that independently minded people who are open to new experiences may engage in divergent thinking* even under adverse circumstances. For less independently minded people, a supportive environment is important [234]. For example, if teachers value creativity, students will have higher grades relative to their peers enrolled in school programs than do not explicitly value creativity [233, 237].

The findings regarding the effects of brainstorming lead to the greater question of expectations about behaviors and attitudes that are acceptable in various group types. Efforts have been made to conceptualize a 'climate' that promotes outcomes. Key variables include individual freedom, psychological safety, support and positive relationships among team members, vision provided by supervisors, creative encouragement, mission clarity, available resources, and even joy [63]. Examples of such conceptualizations are the Team Climate Inventory [331], the Creative Climate Questionnaire by Ekvall [364] and the KEYS by Amabile [9].

One example in education is provided by the few 'democratic' schools. These include Sudbury Valley⁸ in the US and Summerhill school in the UK.⁹ Students are responsible for deciding what and how they learn, who they associate with, and what activities they want to pursue. The staff act as mentors

to support students as opposed to directing their thoughts and behavior. This climate may promote creative traits [103]. However, specific attention is needed to ensure that students develop the requisite executive functions* to carry out what is needed or set deadlines and abide by them.

“ The findings regarding the effects of brainstorming lead to the greater question of expectations about behaviors and attitudes. ”

Meta-analytic studies suggest some variables that are critical across multiple settings. These include challenge, intellectual debate, flexibility, risk-taking, top management support, good relations with managers, and positive interpersonal exchanges [118,120].¹⁰

Complex, challenging and interesting tasks and goals spur intrinsic motivation. Excessive complexity and demand, however, may suggest that the task is undoable and stifle motivation.

Intellectual debate. When working with complex and challenging tasks, problems often surface. They may be novel, complex, and solvable in different ways. To ensure that a project can move forward, many viewpoints must be heard and people must feel secure enough to put forward their best ideas. In organizations where there is no debate, people tend to stick to 'tried and true' ways.

Positive supervisor relations and top management support. Managers should communicate norms that encourage innovation, risk-taking and experimentation, and enacted support. Risk is inherent in innovation. Research shows that tolerating this risk, not minimizing it, is the best strategy. Leaders should publicly recognize and reward creative efforts. This must be shown in action. If resources are not available, employees will see through the rhetoric of encouragement, effectively undermining these efforts.

Positive intrapersonal exchanges.

Joy is an important component of creative climates. When team members experience a sense of 'togetherness' that comes with a common goal, team members will want to cooperate efficiently for their mutual benefit. This increases both team performance as well as individual performance. With increased togetherness, communication is facilitated, which will allow different perspectives and keep conflict away. The research on activating positive moods presented earlier is relevant here and may encourage creativity.

One issue worth discussing further is the influence of conflicts on creativity.¹¹ Conflicts may pertain to tasks of people [127].

Relational conflict negatively impacts creativity and innovation [118]. It may narrow people's range of attention and produce rigid thinking about the tasks at hand. High relational conflict in a team impedes basic functioning, such as information exchange and attentiveness to others' ideas. It reduces creative thinking and innovation. Creative women may be more vulnerable to relational conflicts, particularly from other women [16].

Task conflict refers to disagreements in opinions, viewpoints and ideas about how the group task, and related activities in solving the task, should be performed. Although perhaps counterintuitive, task conflict may trigger creativity and team innovation by challenging the status quo [118, 332]. However,

“ Risk is inherent in innovation. Research shows that tolerating this risk, not minimizing it, is the best strategy. ”

this may depend on personal relationships. The mixed results suggest a curvilinear relationship between task conflict and innovation. The potential for innovative outcomes is at its highest when the level of task conflict is moderate [333, 112]. Absence of task conflicts may not spark the exchange of perspectives and information, nor prompt team members to examine and make sense of goals and objectives. But if the task conflict is too high, communication may break down, effectively stifling exchange of information, knowledge, ideas and perspectives [175].

The need for conflict resolution in workplaces and educational institutions brings up the relationship between **humor and creativity**. Humor is a creative undertaking because it is built on incongruity [182].

More creative individuals may also have a better sense of humor. This quality seems to have evolved in order to reduce hostility. Therefore, the potential exists for creative conflict resolution, particularly with the engagement of humor.



“ Although perhaps counterintuitive, task conflict may trigger creativity and team innovation by challenging the status quo.

”

Individual creativity is sometimes pitted against the interests of social groups, including schools and workplaces. Organizations must manage large numbers of people and deliver certain products. To what extent should they accommodate the creative tendencies of independently minded people who may have limited social skills and a sense of entitlement? The costs and benefits in each case may be carefully considered.

The increased interest in promoting individual creativity sets the stage for some situations that have not been considered before on a large scale. Young people who have been raised to express their creative tendencies may feel oppressed in work environments where they are expected to tailor behavior and deliverables to certain norms. As the number of young people raised in this way increases, larger scale adaptations and debates may be held on this issue.

Creativity and Educational Applications

A. Fostering Creativity in Education

Soon after creativity research and measurement started in the 1950s, it became clear that creativity skills could be trained [253]. Instruction for creative problem-solving gained credence in the 1960s with the studies of Jerome Bruner, who argued that children should be encouraged to “treat a task as a problem for which one invents an answer, rather than finding one out in a book or on the blackboard” [361]. Day-to-day nurture of students’ abilities can have a sizable effect.

Creativity training programs have been developed for a variety of populations in the US and Europe; from kindergarten and elementary school children to athletes and engineering students [106, 334, 335, 336, 337]. The techniques vary considerably both in the approach and in the delivery. Approaches attempt to improve cognitive abilities, personality characteristics, motivation or social interactions [338]. Sometimes they have been criticized for insufficient grounding on evidence [253].

This section offers a sample of the multiple approaches that have been used to develop training programs.

Several packages for creativity training have been based on the belief that creativity occurs in stages (See Chapter 2). Thus, the first step consists of divergent thinking* abilities followed by convergent thinking.* Less structured programs used brainstorming; for example, the Creative Problem-solving program operates on the hypothesis that people are more creative if they begin with an unconstrained idea-generating stage [339, 187].

The following crucial questions have helped design courses based on cognitive research [163].

What to Teach? Problem-solving ability is a collection of small component skills, thus problem-solving courses should provide a collection of smaller component skills.

How to Teach? Students benefit from training in describing and evaluating the methods used to solve problems (i.e., the process of problem-solving).

Where to Teach? It would be more effective to teach problem-solving within the context of specific subject domains* rather than in stand-alone courses.

When to Teach? It might be effective to teach higher-order skills when lower-level skills are mastered.

Programs developed within this four-criterion framework include the Productive Thinking Program [340], and the Instrumental Enrichment Program [342]. These two, along with others presented below, are addressing general thinking skills.

The Productive Thinking Program (1966) consists of 16 cartoon-like booklets intended to teach thinking skills to elementary school children. Each booklet – about 30-page long – presents a detective-type story with two children and two adults as the characters. They serve as models for different problem-solving methods. Students learn how to generate hypotheses and evaluate them using information in the booklet.

For example in ‘The Riverboat Robbery’ the student must attempt to discover who committed the robbery after reading only part of the book. This program has proven to be effective in improving the ability to solve detective-like problems, while improvements in solving problems dissimilar to the one presented during training are inconsistent [341].

The Instrumental Enrichment Program (1980) aims to improve the intellectual abilities of students who had been identified as mentally retarded. It consists of 14 instruments of ‘paper and pencil’ exercises. It is to be used for 2-3 years and is applicable to multiple grades, starting from pre-school (see Figure 20 for an example). In a typical lesson, the teacher introduces the class to an intelligence test item; then, the class breaks down into small groups to devise ways to solve the problem; next, each group reports on its solution method to the whole class; and finally, a teacher-led discussion prompts students to focus on describing effective methods for solving the problem. Evaluation studies showed that adolescent students and students with low-IQ, who received this training on a regular basis over two years, showed greater gains in non-verbal intelligence on tasks similar to the training items than did non-trained students [342, 343].

“ Children should be encouraged to treat a task as a problem for which one invents an answer. ”

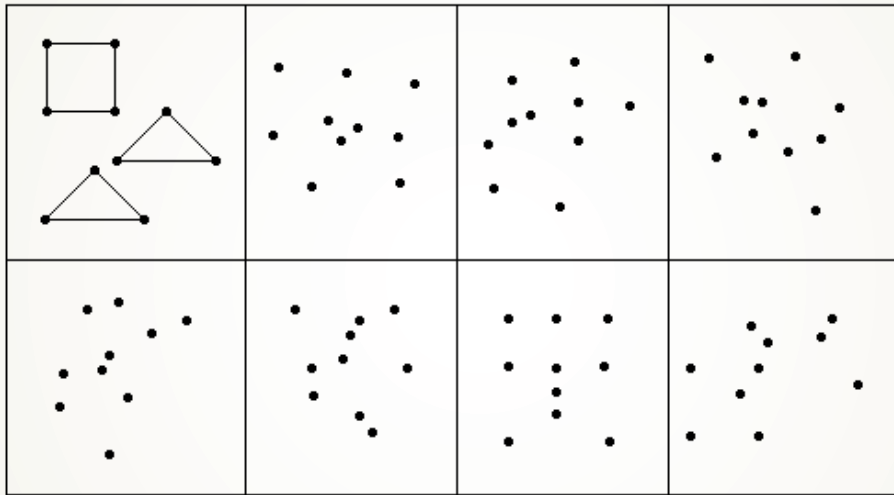

Figure 20. Some items from the Instrumental Enrichment Program.

The student selects dots from the cloud to match the sample model.

The Cognitive Research Trust (CoRT)

(1973) is a program developed in 1973 by Edward de Bono, a Maltese physician [368]. De Bono's six thinking hats use 'lateral thinking'*. All members of a group will focus on a single aspect of a problem by wearing a particular hat, and moving on to another aspect once discussion of the current one is exhausted. For example the Black hat is for judgment, the Green hat for creativity and the Red hat for emotions. De Bono hypothesized that wearing the hat enables the student to develop the relevant thinking skill. The program is divided into six groups with ten lessons in each group, each meant to be administered in one class session. However, evidence of generalized improvements in thinking performance due to CoRT or 'Thinking Hats' tools has been sparse. One evaluation of CoRT reported significant benefits for Venezuelan students of 10 and 11 year-old. [344]. However, a more recent study with Australian aboriginal children [345] found little evidence of generalisation other than in the area of creative thinking [171].

The Purdue Creative Thinking Program

(PCTP) from 1983 consists of 36 audio-taped programs and a set of three to four printed exercises for each program [346]. The audiotope program consists of two parts: a 3-to-4-minute long presentation designed to teach a principle or idea for improving creative thinking and 8-to-10-minute long story of a famous person who made a significant contribution to the development of 'western' societies. Examples are Theodore Roosevelt (lesson 20) and Guglielmo Marconi (lesson 23). Included are printed directions, problems, or questions that are designed to provide practice in originality*, flexibility*, fluency*, and elaboration* in thinking [347]. Training of 14 weeks showed limited effects on divergent thinking* 9 months after training among students in grades 4-6 [348]. Subsequent studies suggest that effects are achieved through programs that give more time or are more structured [219].

B. Domain Specificity and Enrichment

Program results suggest that creative thinking can improve, but improvements are specific to the training topics. If certain functions originate in different parts of the brain, training for one does not necessarily strengthen another.

There is a need to understand better how to improve creativity in everyday circumstances and research must focus on how creativity occurs in natural settings.

One approach has been to infuse creative thinking in the class curricula to offer school children tools to master the subject topics adopting a novel approach. An example is the **School-wide Enrichment Model (SEM)** [349]. It includes: assessment of the students' talent potential; the students' interests and needs; definition of methods to accelerate the advanced handling of the material; and content for creativity enhancement. The latter exposes students to uncommon ideas and explorations in order to simulate creative production in self-selected areas. The method has proven effective in generating novel ideas in children, but it requires highly trained teachers [350]. A more recent program that originated in the United Kingdom uses five creativity dimensions and offers practical suggestions on developing and tracking creativity in schools. The aim is to make learners better able to understand what it is to be creative and use the definition to record evidence of their progress. It also aims to make teachers more precise and confident in developing young people's creativity [154]. The latter is very important, given how challenging teachers may find it to foster students' creativity [198].

One program specific to preschool has been **Tools of the Mind**, in 1996 [351]. It aims to improve the three core mental executive functions* involved in creative problem-solving: cognitive flexibility,* working memory*, and inhibitory control. An example of tool is the Play Planning, aimed at developing self-regulation. A Play Plan usually describes the role and the actions a child will engage in during the first few minutes of play. Children plan their play every day, right before they start playing in the centers. Teachers spend 80 percent of their time explicitly reminding the children to think of alternative ways to solve a problem and building executive function skills. A year-long study showed improved performance of about 25 percent compared to a control group [352].

Clearly, preschoolers benefit from instructions to find novel solutions. Older students also benefit from instructions that promote creativity in curricula. However, the creativity quest must start with detailed and automatized knowledge about concepts and their relations. "To be successful innovators in science and engineering, students must develop a deep conceptual understanding of the underlying science ideas, an ability to apply these ideas and concepts broadly in different contexts, and a vision to see their relevance and usefulness in real-world applications... An innovator is able to perceive and realize potential connections and opportunities better than others" [366].

“There is a need to understand better how to improve creativity in everyday circumstances and research must focus on how creativity occurs in natural settings.”

How to foster the creativity of students enrolled in higher education? Teaching strategies can transform the session into a laboratory experience, emphasizing project-based learning strategies. One example is a course titled “Ciprofloxacin Resistance in *Neisseria gonorrhoeae*” [367]. This seminar introduced college students to important concepts in biology using a real-world context. It is a case study where teams of students play the role of a director of a local public health clinic. One of the county commissioners overseeing the clinic is an epidemiologist who wants to know “how you plan to address the emergence of ciprofloxacin resistance in *Neisseria gonorrhoeae*”. The response must take into account budgetary restrictions for expensive antibiotics and the use of laboratory tests. Student teams must develop a plan to address the medical, economic, and political questions such a clinic director would face in dealing with the problem. They must also provide scientific data to support their conclusions and write a report of the plan. After the course, pre and post-tests showed measurable gains in ability to solve problems about microbiology as well as a general increase in confidence to do so, reflecting perceived problem-solving skills.

Creativity is influenced by attention and executive functions* that are partly under conscious control, so its expression depends on the number of associations stored in memory [167] (see Chapter 2). Therefore knowledge about the neurobiology of creativity may improve performance in divergent thinking.* (By contrast, basic cognitive functions such as memory and perception are not under conscious control. Knowing how memory is stored and retrieved in the brain cannot help Alzheimer’s patients to overcome memory deficits.) Some programs have put this principle to use.

One example is the **Applied Neuro Creativity (ANC)** program. It was (and is still) taught at business schools in Denmark and Canada [185]. Participants are introduced to the cognitive neuroscience of creativity. It was hoped that knowledge about the process would help participants produce the effects. Participants received the brain association training and performed pre and post-test tasks, mostly based on divergent thinking.* In post-tests, students produced many more divergent solutions than peers who did not attend the program (Figure 21). In summary, the results suggest that the inclusion of explicit neuroscience principles in a creativity course can, in 8 weeks, increase divergent thinking* skills with an individual relative average of 28.5 percent [185]. Long-term effects still must be ascertained.

Figure 21. Measuring the results of a brain association training. Adapted from Onarheim, B. et al. (2013): Applying the neuroscience of creativity to creativity training.

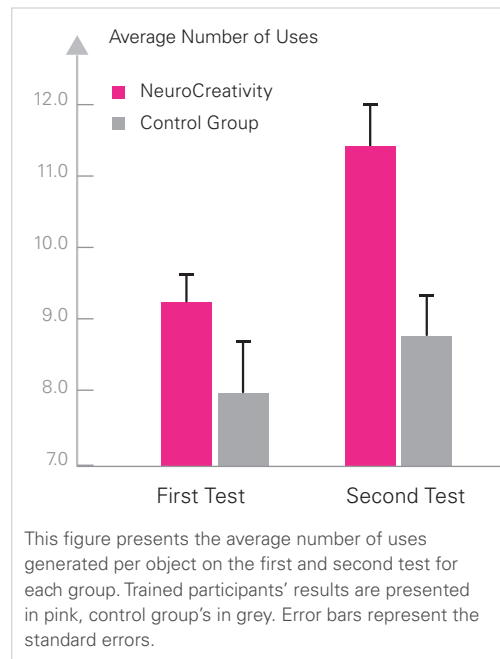

To evaluate program success, suitable measurements are needed. There are many views on how to measure children’s natural ability levels, identify creative giftedness and measure effects of educational training programs [55, 119, 239, 1992, 37, 68, 82, 124, 163]. As mentioned earlier, creative potential has been most often measured by divergent thinking* with ability tests, such as the Torrance Test for Creative Thinking (TTCT) [251]. More details of this test are presented in Appendix 2. Self-reports have also been used, which can be difficult to interpret.

Some standardization is needed in order to compare alternatives. Teachers can foster creativity in the classroom [353]. But what is required in terms of training and knowledge? The goal should be to train students to know enough of the field to make new associations and connections and obtain novel insights. Teachers should have expertise and fluency within a knowledge domain* [354]. There have been few detailed programs about this aspect, and expenses or time requirements have not been clearly considered.

C. The Efficacy of Creativity Training

Above, it was found that training programs work well in promoting the variables assessed in the tests. Of 142 studies reviewed [355] 72 percent of the programs were shown to improve creativity scores. The Creative Problem-solving programs [189], that provide strategies for analyzing problems, were found to be the most effective.

A subsequent article by Scott et al. [219] reviewed 70 studies and measured the degree of treatment success using Glass’s Delta scores [356]. The study also attempted to identify which characteristics of training content and delivery methods contributed to the relative success of the programs as shown in Table 1.

Table 1. Some of the results obtained by Scott et al. (2004): The effectiveness of creativity training: A quantitative review.

Trained population	Dependent variable	Delta	The overall Delta obtained in aggregating effects across criteria (e.g., divergent thinking, problem-solving) was 0.68. This means that the trained participants scored 0.68 standard deviations above the untrained controls or to pre test. Thus, training programs had fairly significant effects on creativity. The largest effect sizes were obtained in courses employing divergent thinking ($\Delta = 0.75$) and problem-solving ($\Delta = 0.84$). Courses applying performance criteria yielded smaller effects ($\Delta = 0.35$), and those employing attitudes and behavior criteria produced the weakest effect sizeable ($\Delta = 0.24$). Creativity training also appeared to have a rather broad impact on various manifestations of divergent thinking yielding sizeable, and similar, effects with respect to fluency ($\Delta = 0.67$), flexibility ($\Delta = 0.75$), and, smaller, albeit still sizeable effects with respect to elaboration ($\Delta = 0.54$).
Males	Overall	1.14	
Females	Overall	0.42	
Occupational	Problem-solving	1.37	
Academic	Problem-solving	0.80	
School (age <14 years old)	Problem-solving	0.72	
Not gifted	Overall	0.72	
Gifted	Overall	0.38	

Surprisingly, female populations got half the benefits of males. This large difference is independent of the dependent measure (divergent thinking or problem-solving). It is possible that training had a weaker effect on females, but no raw data on pre-test or controls performance are provided. Thus, it is possible that some girls had higher starting scores than boys and therefore improved less. As stated in the section about women and gender, various issues with respect to stereotypes and differential expectations may be important.

Another significant finding is that average people benefit more from training than the gifted. This is consistent with previous findings showing that lower-performing individuals may benefit more from various interventions [357]. One implication is that creativity programs should be addressed to the average rather than the excellent students.

Successful interventions tended to be based on cognitive improvements [219]. The Purdue Creative Thinking program [346] and the Creative Problem-Solving program [339, 358, 189] were the most effective interventions studied. Problem identification, idea generation, implementation planning, solution monitoring, and conceptual combination were found to be positively related to program success. They enabled students to solve novel and ill-defined problems, and the training had a deeper impact on specific skills. Rigor and good use of instructional time contributed to learning and performance, as well as the amount of practice. By contrast, unconstrained exploration, brainstorming, or imagination exercises were the least effective.

Overall, use of domain-based performance exercises was positively related to effect size. Thus, the success of creativity training appears deeply linked to providing people with strategies, or heuristics, for working with specific information subjects.

D. The Long-Term Effects of Training

One important aspect of training is sustainability. Education ought to result in improved decision-making and quality of everyday life. Unfortunately, evidence from longitudinal studies on the effect of training on applied creativity is almost absent. The divergent thinking* abilities of highly creative children were assessed from grades 1 to 12 longitudinally; results indicated that an enrichment treatment was effective up through the 6th grade [359].

Some longitudinal studies investigated the ability to produce creative artifacts in groups of young artists. Interestingly, some of the potentially most creative persons enrolled in art classes stopped doing art and pursued other occupations, while those with more limited skills persevered, producing major creative achievements [56, 59].

“ Average people benefit more from training than the gifted. This is consistent with previous findings showing that lower-performing individuals may benefit more from various interventions.

”

Therefore skills do not automatically translate into creative products. Nonetheless, in the context of educational policy, creativity may enhance the probability that a larger portion of society would be in the position of generating innovations. But are the students prepared for this role? Some information raises a few concerns.

E. Are Creativity Scores Dropping in Some Countries?

During the last decades, intelligence scores have risen worldwide, and there has been much educational investment that ought to enhance creativity [360]. One would therefore expect improvement also in the various expressions of creative thinking. However, the Torrance creative thinking test scores in the United States have significantly decreased since 1990. The decrease for kindergartners through third graders was the most significant [136].

The findings have been hard to interpret. The effect has sometimes been attributed to the need for test preparation and engagement in learning essential procedures and knowledge items. However, other possibilities exist. For safety reasons, for example, children engage in supervised rather than free play. Therefore they have few opportunities to pursue and structure their knowledge networks on their own. It is unclear whether the responses to alternate uses of ordinary objects best prepare students for technologically complex tasks.

F. OECD's Efforts to Assess Creative Problem-Solving Internationally

Assessment more pertinent to real-life problems would be needed. As economies and societies grow ever more complex, success in life and work is increasingly determined by our ability to adapt to new situations, learn from mistakes, and try out new approaches. Are these the qualities of today's 15-year-olds? The Programme for International Student Assessment (PISA)* 2012 round investigated this question with a special set of assessments based on creative problem-solving. Testing encompassed about 85,000 15-year-olds in 44 countries and partners of the Organisation for Economic Co-operation and Development (OECD).*

The test was computer-based; it tackled real-life, interactive problems, such as programming an MP3 player and planning a route. The aim was to assess how well 15-year-olds could resolve problems with no immediately obvious solutions, so demonstrating their openness to novelty, their ability to tolerate uncertainty and their capacity to reason in order to reach their goals. Results enable for macro comparisons across countries. Parallel comparisons with the educational policies in place in the various countries to foster creativity, may be indicative of the successful strategy.

The results (OECD, 2014) show that students in Singapore and Korea, followed by students in Japan, score higher in problem-solving than students in all other participating countries and economies. Four more East Asian partner economies rank between 4th and 7th place: Macao-China, Hong Kong-China, Shanghai-China, and Chinese Taipei.

And the following countries scored above the OECD average: Canada, Australia, Finland, England (UK), Estonia, France, the Netherlands, Italy, the Czech Republic, Germany, the United States and Belgium (in descending order of their mean scores).

In the two best-performing countries – Korea and Singapore – 15-year-old students can solve moderately complex problems working around the malfunction of an unfamiliar subway ticket machine that is only discovered after multiple steps (level 4).

They can form a hypothesis about why the device is malfunctioning and describe how to test it. By contrast, in the lowest-performing countries, more than 50 percent of students are only able to solve very simple problems that do not require them to think ahead – such as determining, through trial-and-error, which solution among a limited set of alternatives best meets a single criterion (tasks at Level 1, see Figure 22).

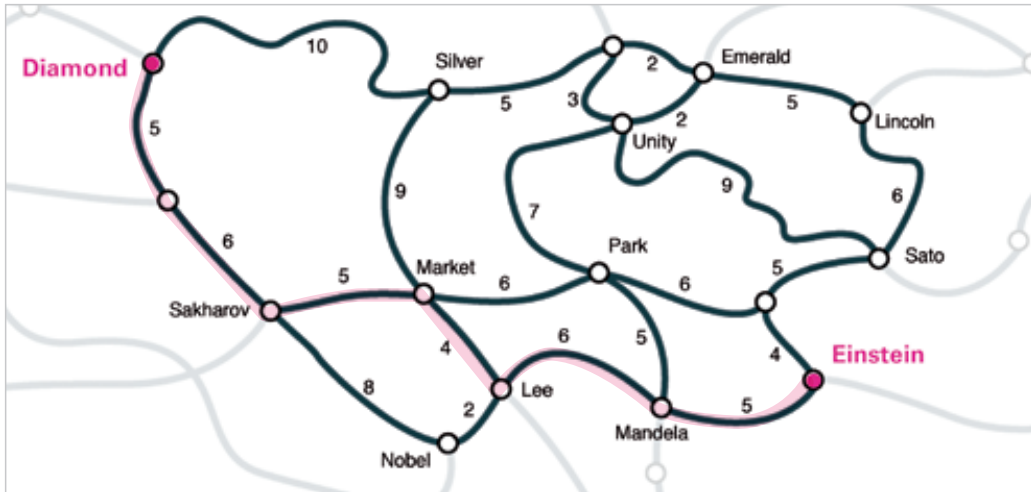
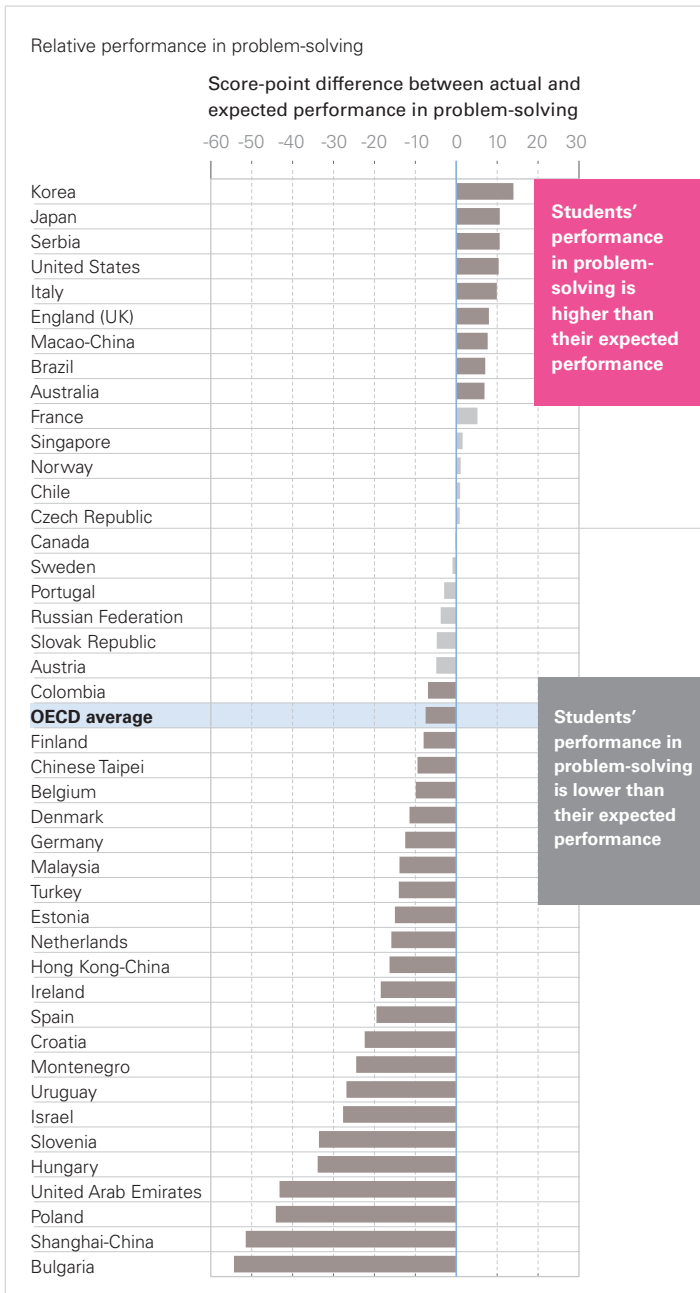

Figure 22. An example of item assessing problem-solving at level 1 in the PISA test.

The road map indicates with numbers the time needed to transit the roads. The task of the child is to find the fastest way to go from Diamond to Einstein. The colored street is the correct solution.

“ The results (OECD, 2014) show that students in Singapore and Korea, followed by students in Japan, score higher in problem-solving than students in all other participating countries and economies. ”



Problem-solving and knowledge acquisition

However, even in the best-performing countries, many 15-year-olds lack the problem-solving skills considered necessary to succeed in today's world. Many of the best-performing countries and economies in problem-solving are those with better-than-expected performance on knowledge-acquisition tasks in math and science, which require high levels of reasoning skills. In order to solve interactive problems, students need to be open to novelty, tolerate doubt and uncertainty, and able to use intuition to initiate a solution. Students who do well in mathematics, reading and science also tend to show strong performance in problem-solving and do well when confronted with unfamiliar problems in contexts outside of school subjects. These students are better equipped to develop coherent mental representations of problem situations and plan ahead in a focused way. In Italy, for example, students perform significantly better in problem-solving than what was expected from their scores in mathematics, reading and science (see Figure 23).

Figure 23. Differences between actual and expected performance in problem-solving based on math and science skills. Dark grey bars indicate a significantly different performance. Source: OECD, PISA 2012 Database, Table V.2.6.

Strategies for improvement

Public policy and training cannot easily improve the innate components of creativity. However, expected improvements may come from an adequate and well-implemented curriculum; 23 percent of the performance variation among PISA students was observed at the system level, 31 percent was observed at the school level, and 46 percent was observed at the student level. This indicates that there is a large margin of improvement in problem-solving where governments, administrators and teachers can make a difference.

How can schools and teachers help children in developing complex problem-solving skills? Various possibilities exist. Greater emphasis is needed in classrooms on solution strategies for specific subjects in class [349; 350].

The example of Singapore

Some countries that outperformed in problem-solving skills such as Singapore have recognized the need to foster these abilities in the curriculum. In 1997 Singapore launched a project called “Thinking schools, Learning Nation” that contained a review of the curriculum and assessment giving greater importance to the evaluation of thinking and problem-solving skills (MOE, 1997). Subsequently, Singapore identified the competences considered important among which ‘critical and inventive thinking’, ‘communication’, and ‘collaboration and information skills’ (MOE, 2014). These competences now guide the development of the national curricula as well as the school-based programs together with the extensive use of the Information and Communication Technologies (ICT) [140]. ICT has impacted on the quality and quantity of teaching, learning, and research in traditional and distance education institutions. In concrete, ICT can enhance teaching and learning through its dynamic, interactive, and engaging content; and it can provide real opportunities for individualised instruction. Inadequate policies regarding the integration of ICT in the country’s education system, as in the case of Nigeria, may have limited effects on education systems [275].

“ There is a large margin of improvement in problem-solving where governments, administrators and teachers can make a difference. ”

Looking at the score distributions in PISA 2012 relative to the educational system implemented in the various countries, some comments can be made. They are important because of the correlation between maths abilities, problem-solving and creativity.

There are differences across educational policies in the ways in which students progress through grade levels as they become older. School systems where students of the same age are in multiple grade levels tend to have lower overall performance in mathematics. To some extent, this is the expected result of the effort by some countries to make education more inclusive by accommodating students who started school at relatively late ages or who are at greater risk of dropping out.

Educational systems also differ in the type of instruction provided within a grade level. In particular, the impact of the socio-economic status of students and/or schools on performance is stronger in school systems that sort students into different tracks based on their performance. The relevant factors seem related to the age at which differentiation is implemented. In systems where these decisions are taken at an early age, children's advancement is bound to family opportunities, while later in life students play a larger role in deciding their own education pathways.

This is evident from the overall math results. It is worth noting that Qatar is fifth from the top among the countries that select students early, performing poorly in math tasks. While countries that outperform in math (Korea, United States, Serbia, Japan, Finland, Italy) do not typically select (lower than OECD average).

The take-home message is that in the most successful educational systems children enter school at the same age and progress through school with a similar curriculum until they are old enough to take part in the decisions.

Finally, the influence of the spending policy on the outcome is somewhat more complex. There seems to be a lower threshold of US\$40,000 average spending for each student from age 6 to 15. Below this limit, performance scores are positively related to the amount of spending; above this cut-off the average scores are independent of the amount spent.¹²

“ In the most successful educational systems, children enter school at the same age and progress through school with a similar curriculum until they are old enough to take part in the decision regarding their education pathway. ”

Conclusions and Implications

A feature commonly called ‘creativity’ clearly exists. Neuroscientific studies have repeatedly identified rather consistent brain activity patterns that can be attributed to it. Neuroimaging captures attention, searches through the memory networks; mingling of information into working memory, moments of insight and illumination can be captured, as well as evidence for flexible change among various topics in mind. It also captures the curious release of creativity when people are at rest.

The research on creativity covers vast areas. It is linked to genetics, personal experiences, educational levels, personality traits, mood types, social interactions, and incentives. Predictably, the relationships among various variables are complex and non-linear. Some aspects characterize all creative output, but others pertain to specific domains, such as art, or are more likely to appear under specific circumstances.

Very roughly, creativity comes from two sources: (a), reliance on knowledge, memory, native intelligence, and executive control* and (b) reliance on the brain’s resting state. Relatively average people seem to rely more on their

memory functions and knowledge store for insights. People with unusual, ‘Big-C’ creativity may have an overly active resting-state network. Mental illness shares this tendency, and this is one reason why some eminent geniuses have eccentric personalities. Of course, native intelligence as well as an overactive resting-state network may co-exist and multiply effects.

“ Suitable education should include not just automatized basic skills but also enrichment experiences that habituate minds to change domains quickly and flexibly. ”

The creativity of relatively average people points to the need for prior knowledge. Particularly important is plentiful and automatized information that rushes into someone's mind as he or she thinks. think. This is one reason why creativity depends on education. Feats of engineering, for example, are much more likely when someone already knows a lot about the subject. Trained individuals with average genetic endowment for problem-solving in their field find solutions that would require genius-level brainpower to obtain without suitable training.

Suitable education should include not just automatized basic skills but also enrichment experiences that habituate minds to change domains quickly and flexibly. Multicultural experiences, multilingualism, challenging choices, life in cities, even adverse conditions force people to connect parts of their memory network that do not normally connect. Perseverance* to overcome adversity or convince others may also build executive control, which in itself is important in obtaining creative answers.

One, somewhat counterintuitive implication for schools is a need for time to automatize the skills necessary for a level of education as well as time to engage in complex, critical thinking about content. Students may feel bored with memorizing essential facts or overlearn and automatize skills such as math operations. There is a tendency for schools and parents to shorten or avoid such routine tasks. However, memory functions require the speed and easy access that practice produces. Furthermore, tolerance and strategic thinking on dealing with such tasks may develop the executive functions* needed to persevere in the production of innovations in the labor market.

In educational institutions or workplaces there is often a need to maintain a stream of creative productions. A positive mood may activate some workers but not all. Creativity may be optimized though a 'yin and yang' between demands and time to relax, permitting some solutions to come. Unremitting attention towards solving a problem, accompanied by caffeine, may facilitate a correct solution, but it may not be the most creative.

Teamwork has been greatly emphasized with respect to innovations, but group dynamics may reduce the creative productions of some people. In some respects it may be best if people think of ideas on their own and anonymously interact with the group (e.g. through software). Team competition or moderate task conflict may increase creative output, but it has gender effects. Men may perform, but women may need collaboration rather than competition to excel in productivity. Interpersonal conflicts seem to diminish innovativeness for all.

Creative thinking can certainly be taught. Training programs work well overall, particularly when they strengthen the bedrock of cognition rather than engage in brainstorming or imagining.

“There is a need for training that increases the probability of solutions in general rather than domain-specific terms and for a lifetime.”

“ It is unclear whether a creativity intervention will have long-term effects or what the duration may be.

”

Average learners benefit more than top students. However, the effects have involved specific domains and short periods of time. There is a need for training that increases the probability of solutions in general rather than domain-specific terms and for a lifetime. Such training can most easily be conducted in elite schools, but average or below-average schools could do more to improve. This would most easily happen if some creativity essentials were inserted into the curricula of various subjects. Teachers are an important variable. This is challenging work, and better preparation is needed to foster creativity.

The findings have certain **implications** that deserve further research. Some of these are discussed below.

Research has mainly been conducted in high-income countries of the ‘west’, notably in the United States. Its applicability to other cultures must be ascertained. The findings regarding the general characteristics of creativity may be more robust for worldwide consumption, because they depend on genetics and on information-processing mechanisms that are common to all humans. But assessment instruments require more consideration. Creativity has been measured through tasks such as divergent thinking tasks, and it is unclear how widely the various tasks are replicable. Some may not be socially acceptable in certain areas or for certain groups (including women).

Another issue is the relevance of experimental conditions to everyday reality. Tests must necessarily last for a few minutes, but in real life people seek solutions to problems over days or weeks. Creativity to some extent is in the eye of the beholder, so test tasks depend on ratings and raters’ opinions. Their judgments have limitations. For research and publication purposes, the procedures have been adequate, but it is unclear how reliable creativity criteria would be if public funds were to be spent and rigorous evaluations were conducted.



**“Thank you for calling Creative Business Seminars.
If you’d like to become a more creative problem solver,
press 1 without touching any part of your telephone.”**

“ In principle, efforts should be made to strengthen the schools of lower-income students in training for creative solutions.

”

One caveat pertaining to training programs is attribution of causality. Studies thus far have been short-term and with multiple limitations. It is unclear whether a creativity intervention will have long-term effects or what the duration may be. Improvements may be due to enriching life experiences rather than the programs. And will training to produce ‘little-c’ creativity lead to better decisions and greater life satisfaction? Will training lead systematically from ‘mini-c’ to ‘Pro-c’ or even to ‘Big-C’? It is important to find answers to such questions.

Targeted training of average students in the bedrock principles that underlie divergent thinking seems to have worthwhile effects, particularly for STEM topics. One question is how well the average or below-average teachers can deliver such training, even aided by computer software.

In some respects, creativity training is already taking place in many homes and classrooms of the world. Children of middle-class families have opportunities for enrichment that according to research, should lead to more creative solutions. Schools serving these population segments have resources and well-trained teachers, who may be able to provide challenging work to the students. By contrast, lower-income students may practice

creative skills in solving daily problems and perhaps in adverse circumstances. As the PISA data show, the score gap among OECD learners is smaller than would be expected on the basis of socioeconomic status. Nevertheless, the gap exists. In principle, efforts should be made to strengthen the schools of lower-income students in training for creative solutions. The material may be challenging for most teachers, but nowadays computer training is feasible and widespread at least in middle-income countries. Lower-income students may benefit.

Extensive promotion of creativity is likely to have vocational implications. The arts are easier to train in, and students may want to pursue such dreams professionally. There is a limited demand for singers, musicians, sculptors, or decorators, and this means competing against millions of others who want to do the same. Ultimately some people may be worse off after spending years in studies that may not give them a decent income. Given the domain specificity of creativity, investments could be aimed at STEM rather than at overall enhancement.

“ Given the domain specificity of creativity, investments could be aimed at STEM rather than at overall enhancement. ”

“ A sizeable corpus of gender research suggests that female outliers may not be highly regarded at work or school. ”

There are some challenges in the expression of creativity by girls. Their brains seem to arrive at solutions through different routes than boys'. The importance of such findings must be evaluated and understood better. Perhaps some of the training ought to be specifically directed at girls. Equally important, however, are the social consequences of women who are highly creative in the workplace. A sizeable corpus of gender research suggests that female outliers may not be highly regarded at work or school; competitive events may pit them against other women and raise resentments. Indeed, the differential performance of women in some tests may be affected by the social difficulties that they face.

Creativity is defined by precedent. In earlier centuries, technologically feasible discoveries had very significant effects on civilization. Currently similar levels of creativity may result in less important innovations, simply because the big ones have been made. On the other hand, humans are being faced with new frontiers. For example, global warming must be reversed. What mixtures of education and 'c' should teams have to maximize the probability that solutions will be found in time? These are the big prizes of the future.

The better off may be more creative, but sustaining the trend is challenging. Schools have been pressured to reduce stress on students, partly in hopes that happy students will be more creative.

However, research shows that creativity results from strictures and a need to find answers. It may be difficult to create serious innovations without a specific motive or timeframe. Creativity requires executive functions,* such as perseverance.* Permitting students to escape practice or courses they consider boring may reduce the amount of time spent in automatizing basic skills and in persisting for creative solutions.

Large-scale investments are often made to test and market innovations. It is unclear, however, whose ideas may prevail. Social class, political influence, and gender credibility may ultimately decide whose innovation gets funded and marketed. And the pool of innovations that can be put to use seems limited. Some theories of creativity (e.g. honing theory of Liane Gabora) suggest that it is impossible for everyone to innovate in a field. For innovations to succeed, there must be imitators. It is important to explore this line of research and understand its implications.

In environments where many better-off students work or study, questions may arise regarding the personality traits of highly creative people. Such people (usually male) may come to work with a long line of successful experiences. There may also be a competition for their services. Therefore they may be challenging to manage. More experiments and research are needed on how to manage highly creative people, who however, may hesitate to fit into educational or corporate structures. Ethical management of creative tendencies may also be important in some contexts.

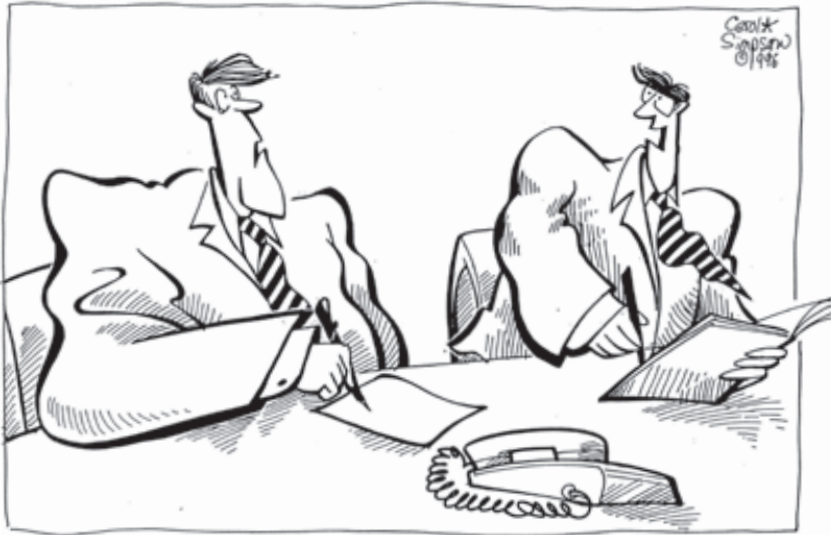

"We fired all the troublemakers six months ago... around the time this company generated its last original idea."

To increase the creativity of poorer students in low-income areas, high-quality education is important in basic skills. These are necessary for the acquisition of automatized and rapidly retrieved knowledge that will lead to creativity, and many students fail to develop these skills. However, the rules of memory are biological and therefore not negotiable; little is possible unless low-income students somehow acquire automatized basic skills.

Despite some of these caveats, the outlook towards exploring creativity is optimistic. Ongoing neuroscientific research provides distinct insights on how creativity arises in the brain. There is much that science does not know, but technology, equipment and protocols are evolving. With additional research, it may be possible to facilitate greatly the acquisition of creative problem-solving in the future.

“ Some theories of creativity suggest that it is impossible for everyone to innovate in a field. For innovations to succeed, there must be imitators. ”

The final thoughts in this document turn again to Ramanujan. He had sufficient perseverance* and ability to express the visions that he experienced, so that his voice can still be heard, about 75 years after his death. It would be hoped that policies to optimize the expression of creativity would enhance the ability of brains that may appear once in a generation to rise to the highest levels of actualization.



ANNEXES

Endnotes 76

Appendices 77

References 81

Glossary 97



Endnotes

1. <http://www.dailymail.co.uk/sciencetech/article-2254352/Deathbed-dream-puzzles-renowned-Indian-mathematician-Srinivasa-finally-solved--100-years-died.html#ixzz3BtN8wng9>
More about Ramanujan: http://www.hinduwisdom.info/quotes321_340.htm
2. Merriam Webster dictionary, <http://www.merriam-webster.com/dictionary/creativity>
3. Merriam Webster dictionary <http://www.merriam-webster.com/dictionary/innovation>
4. See example in http://www.cengage.com/collegesuccess/book_content/1413031927_santrock/ch05/ch05exe6.html
5. http://dangerousminds.net/comments/ernest_hemingway_and_the_six-word_short_story
6. <http://www.theatlantic.com/features/archive/2014/06/secrets-of-the-creative-brain/372299/>
7. <http://www.motherjones.com/environment/2014/08/inquiring-minds-barbara-oakley-learning-neuroscience>
8. http://www.sudval.com/05_onepersononevote.html
<http://www.education.com/magazine/article/sudbury-school/>
9. <http://www.summerhillschool.co.uk/>
and <http://www.theguardian.com/education/2013/may/27/summerhill-school-head-profile>
10. Blog article by Leift Denti in Innovation Psychology, 2013 :
<http://www.innovationmanagement.se/2013/05/22/top-six-components-of-a-creative-climate/>
11. <http://www.innovationmanagement.se/2012/09/06/conflict-in-teams-does-it-stimulate-creativity-innovation/>
12. OECD, PISA 2012 Database, Tables I.2.3a and IV.3.1

Credits

p37: Cartoon by Joseph Farris - CartoonStock.com
p41: Cartoon by Frits Ahlefeldt - hikingartist.com
p43 and 51: Cartoons by Bradford Veley - CartoonStock.com
p45: Cartoon by Shaun McCallig - CartoonStock.com
p55: Cartoon by Mr. Fish
p70: Cartoon by Randy Glasbergen - glasbergen.com
p73: Cartoon by Carol Simpson Cartoons - cartoonwork.com

Appendices

Appendix 1:

Review methodology

Thousands of studies have been conducted on creativity; until August 2014, just Medscape, a U. S. collection of scientific studies, listed 4176 experimental studies that contained this word in the title. To deal with this volume constructively, this review focused on articles and studies that reviewed earlier research. Considerable attention was given to applications and lines of reasoning that may help develop a causal chain for education policies of various stakeholders. Effort was also made to present research that validates or refutes commonly held beliefs.

Roughly, creativity studies cover the following domains:

Cognitive models and behavioral research.

From Francis Galton in 1869 to Sigmund Freud, researchers have had various conceptions of what constitutes creativity and how it happens. These hypotheses and behavioral data have led to the development of measurement methods and training programs. Issues such as the relationship between intelligence and creativity have been dealt through such research.

Studies of unusually creative people. Many theories about creativity arose from studies of mental illness and other pathologies: schizophrenia, depression, and autism. Some publications of this sort are observational, detailing the lives of eminent creators, such as Vincent van Gogh. Related to the topic are personality variables that promote creativity. Neuroscientific studies are offering insights to the ways their brains function and the sources of unusual ideas.

Issues involving genetics and brain research.

Studies that examine data produced by the brain have become feasible. They still have uncertainties, such as interpretations of various findings. But in principle it is possible to observe the changes in people when they are engaged in an activity likely to be creative, such as improvising on a keyboard. Some studies have also focused on the particular brain functions of highly creative people.

Social and group norms related to creativity.

Several studies have explored the emergence or suppression of creative thinking in a group environment.

Evolutionary aspects of creativity. Some studies have focused on the evolutionary utility of creativity and the reasons why this activity has been considered socially desirable.

Some caveats and limitations

The vast majority of creativity studies originated in high-income countries of the 'west'. The extent to which findings can be generalized to other populations is unclear. However, the research shows that creativity uses information-processing mechanisms of the brain that appear to be common in all humans: long-term and working memory,* attention, executive function.*

Specific expressions of creativity may differ across cultures, particularly considering educational levels, opportunities, cultural norms, political expressions, and income levels. The challenge of the review is to inform stakeholders regarding the desirability and type of interventions to enhance creative states.





Appendix 2:

Examples of Creativity Tests for Educational Purposes

The Torrance Test for Creative Thinking (TTCT)

battery was developed in the US. It is composed of verbal and figural tests. The verbal test is comprised of five activities, and the figural is comprised of three activities. Responses to the verbal and figural tests of the TTCT represent measures of different creative abilities as demonstrated by the low correlation (0.06) between them [252]. The TTCT-Verbal has two parallel forms and consists of five activities: ask-and-guess, product improvement, unusual uses, unusual questions, and just suppose. The stimulus for each task includes a picture to which people respond in writing [248, 251]. The TTCT-Figural also has two parallel forms and consists of three activities: picture construction, picture completion, and repeated figures of lines or circles. Test instructions are designed to motivate the respondents to give unusual and detailed responses.

The TTCT can be administered as an individual or group test from the kindergarten level through the graduate level and beyond. The test was initially scored on four scales or domains, e.g., fluency*, flexibility*, originality* and elaboration.* However it has been re-normed four times in the US: in 1974, 1984, 1990, and 1998. Finally, the test is composed of two norm-referenced measures of creative potential, abstractness of titles and resistance to premature closure, were added to fluency, originality, and elaboration. One measure of flexibility (scored by the variety of categories of relevant responses) was eliminated because it correlated very highly with fluency [111]. Positive features of the TTCT include the wealth of information available on it, the short time needed for administration, and the ease of its administration [245]. It has fewer limitations and cautions to apply, and it is more researched and analyzed than any other creativity instrument [129, 245, 254]. The standardized administration, scoring procedures and norms, and the development and evaluation [60] have made the TTCT especially useful for identifying gifted and talented students. Torrance (1971) and Torrance & Torrance (1972) have found little evidence of race or socioeconomic bias. In fact the TTCT sometimes favors Afro-American children and children of low socioeconomic backgrounds.

A second major tradition for measuring creative potential has been the use of constrained production tasks.

In these tasks, the goal is to produce a single, developed 'work' taking into account a set of imposed constraints. For example, children may make a drawing based on a specified topic, make a collage using a set of provided materials, or write a story based on a specified title. The Test of Creative Thinking- Drawing Production (TCT-DP) gives a page with several graphic sketches placed in certain locations (such as a semi-circle placed in the upper left corner of the page) and asks the child to make a drawing that incorporates these elements [258]. There are a variety of scoring systems to evaluate the creativity in these production tasks. Consensual assessment is frequent [7], in which qualified evaluators rate the productions (using a 7-point scale from low to high creativity, for example). The average rating for a production, over several judges, is the creativity score. For the TCT-DP, a system composed of several subscores which measure specific characteristics relevant to creative potential (such as the number of graphic elements used, unconventionality of ideas, use of humor) has been developed by Urban [257] and Urban and Jellen [258].

Lubart et al. (2010) studied the relations between different scoring systems, like judges' evaluations, statistically based originality scores, and scores based on specific content within the same creative production task. The authors also examined relations between scoring systems across creativity tasks. They found that the three had moderately good but not perfect correlations. Examining the relations among different creative tasks, the study highlighted positive but weak correlations, which seem to corroborate the hypothesis of domain specificity of creativity [14, 15]. To cover the domain as much as possible, it is preferable to use multiple scoring systems and several tasks, such as divergent thinking* and constrained production tasks [153].

Appendix 3:

The impact of mood on divergent thinking

Akbari Chermahini and Hommel [6] tested the hypothesis that the impact of mood on divergent thinking* may depend on a given individual's steady dopamine* level. They did so in adults by assessing mood, performance in a divergent thinking task, and eye blink rates (EBR). Eyeblink rate is a clinical marker of the individual dopamine level. Figure 24 shows that flexibility, a measure of divergent thinking* is maximal for median levels of dopamine and decays for low and high levels. Positive mood induction improves the dopamine level measured by eyeblinks. However, only individuals with below-median eyeblink rates, benefited from a positive mood (Figure 25).

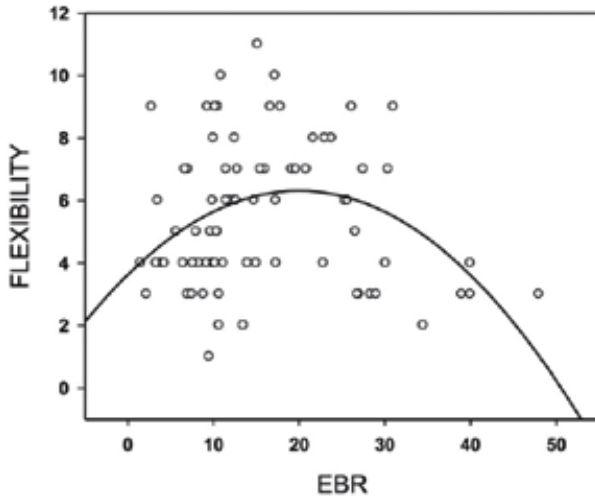

Figure 24. The non-linear relationship between divergent thinking (cognitive flexibility) and dopamine level (EBR stands for eye blink rate). From Akbari Chermahini & Hommel (2012): More creative through positive mood? Not everyone!

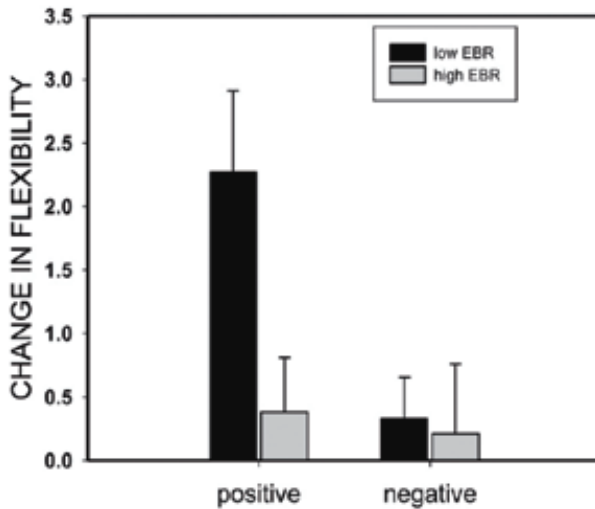

Figure 25. Positive mood raised flexibility only in people with below-median dopamine levels. From Akbari Chermahini & Hommel [47].

References

- [1] Abraham, A., Thybusch, K., Pieritz, K., & Hermann, C. (2014). Gender differences in creative thinking: behavioral and fMRI findings. *Brain imaging and behavior*, 8(1), 39-51.
- [2] Abraham, A., Windman, S., Siefen, R., Daum, I., & Guntukun, O. (2006). Creative thinking in adolescents with attention deficit hyperactivity disorder (ADHD). *Child Neuropsychology*, 12 (2), 111–123.
- [3] Abraham, A., & Windman S (2007). Creative cognition: The diverse operations and the prospect of applying a cognitive neuroscience perspective. *Science Direct – Methods*, 42, 38-48
- [4] Abraham, A., & Windman S (2008) Selective information processing advantages in creative cognition as a function of schizotypy. *Creativity Research Journal*, 20, 1-6
- [5] Adarves-Yorno, I., Haslam, A. S., Postmes, T. (2008) And now for something completely different? The impact of group membership on perceptions of creativity. *Social Influence*, 3(4), pp.248-266.
- [6] Akbari Chermahini, S. & Hommel, B. (2012). More creative through positive mood? Not everyone! *Frontiers in Human Neuroscience*, 6.
- [7] Amabile (1982). Social psychology of creativity a consensual assessment technique. *Journal of Personality and Social Psychology*. 43, 997-1113.
- [8] Amabile, T. M. (1983). *The social psychology of creativity*. New York: Springer.
- [9] Amabile, T.M.(1996).*Creativity in context*. Boulder,CO:Westview.
- [10] Andreasen, N. (2006). *The Creative Brain: The Science of Genius*. Plume.
- [11] Ashby, F. G., & Isen, A. M. (1999). A neuropsychological theory of positive affect and its influence on cognition. *Psychological review*, 106(3), 529.
- [12] Aziz-Zadeh, L., Kaplan, J. T., & Iacoboni, M. (2009). "Aha!": The neural correlates of verbal insight solutions. *Human brain mapping*, 30(3), 908-916.
- [13] Aziz-Zadeh, L., Liew, S. L., & Dandekar, F. (2013). Exploring the neural correlates of visual creativity. *Social cognitive and affective neuroscience*, 8(4), 475-480.

- [14] Baer, J. (1998). The case for domain specificity of creativity. *Creativity Research Journal*, 11(2), 173-177.
- [15] Baer, J., & Kaufman, J. C. (2005). Bridging generality and specificity: The Amusement Park Theoretical (APT) Model of creativity. *Roeper Review*, 27, 158-163.
- [16] Baer, M., Vadera, A. K., Leenders, R. T. A., Oldham, G. R. (2014). Intergroup Competition as a Double-Edged Sword: How Sex Composition Regulates the Effects of Competition on Group Creativity. *Organization Science*, 25, 3, 892-908.
- [17] Ballarini F, Martinez MC, Diaz Perez M, Moncada, D., Viola H. (2013) Memory in Elementary School Children Is Improved by an Unrelated Novel Experience. *PLoS ONE* 8(6): e66875. doi:10.1371/journal.pone.0066875
- [18] Barrett, L. F., & Russell, J. A. (1998). Independence and bipolarity in the structure of current affect. *Journal of Personality and Social Psychology*, 74, 967-984.
- [19] Basadur, M., Gelade, G., & Basadur, T. (2013). Creative Problem-Solving Process Styles, Cognitive Work Demands, and Organizational Adaptability. *The Journal of Applied Behavioral Science*, 0021886313508433.
- [20] Bastick, T. (1982). Intuition: How we think and act.
- [21] Beaty, R.E., & Silvia, P.J. (2012). Why do ideas get more creative across time? An executive interpretation of the serial order effect in divergent thinking tasks. *Psychol. Aesthet. Creat.* 6, 309-319.
- [22] Bechtereva, N., Korotkov, A., Pakhomov, S., Roudas, M. S., Starchenko, M., & Medvedev, S. (2004). PET study of brain maintenance of verbal creative activity. *International Journal of Psychophysiology*, 53, 11-20. doi:10.1016/j.ijpsycho.2004.01.001.
- [23] Beghetto, R. A., & Kaufman, J. C. (2007). Toward a broader conception of creativity: A case for mini-creativity. *Psychology of Aesthetics, Creativity, and the Arts*, 1, 73-79.
- [24] Beghetto, R. A., & Plucker, J. A. (2006). The relationship among schooling, learning, and creativity: "All roads lead to creativity" or "You can't get there from here?" In J. C.
- [25] Benedek, M., & Neubauer, A. C. (2013). Revisiting Mednick's Model on Creativity-Related Differences in Associative Hierarchies. Evidence for a Common Path to Uncommon Thought. *The Journal of creative behavior*, 47(4), 273-289.
- [26] Benedek, M., Bergner, S., Könen, T., Fink, A., & Neubauer, A. C. (2011). EEG alpha synchronization is related to top-down processing in convergent and divergent thinking. *Neuropsychologia*, 49, 3505-3511.
- [27] Benedek, M., Jauk, E., Fink, A., Koschutnig, K., Reishofer, G., Ebner, F., & Neubauer, A. C. (2014). To create or to recall? Neural mechanisms underlying the generation of creative new ideas. *NeuroImage*, 88, 125-133.
- [28] Benedek, M., Könen, T., & Neubauer, A. C. (2012). Associative abilities underlying creativity. *Psychology of Aesthetics, Creativity, and the Arts*, 6(3), 273.
- [29] Benet-Martinez, V., Lee, F., & Leu, J. (2006). Biculturalism and cognitive complexity: Expertise in cultural representations. *Journal of Cross-Cultural Psychology*, 37, 386-407. DOI:10.1177/0022022106288476
- [30] Berlin, L., Guthrie, T, Weider, A, Goodell, H, Wolff, HG (1955) Studies in human cerebral function: the effects of mescaline and lysergic acid on cerebral processes pertinent to creative activity. *J Nerv Ment Dis* 122: 487-491.
- [31] Bhatti, Yasser Ahmad, Khilji, Shaista E and Basu, Radha. (2013). Frugal Innovation. In S. Khilji & C. Rowley (eds). *Globalization, Change and Learning in South Asia*. Oxford, UK: Chandos Publishing.
- [32] Bindler L, Anheim M, Tranchant C, Vidailhet P. (2011). La créativité du patient parkinsonien. *Ann Med Psychol (Paris)*; 169:104-107.
- [33] Boden, M. (1991). *The Creative Mind: Myths and Mechanisms*. New York: Basic Books.
- [34] Botvinick, M.M., Cohen, J.D., & Carter, C.S. (2004). Conflict monitoring and anterior cingulate cortex: An update. *Trends in Cognitive Sciences*, 8, 539-546.
- [35] Bourassa, M. & Vaugeois, P. (2001) Effects of Marijuana Use on Divergent Thinking. *Creativity Research Journal*, 13, 3-4, 411-415.
- [36] Bowden, E.M., & Jung-Beeman, M. (2003). Aha! Insight experience correlates with solution activation in the right hemisphere. *Psychonomic Bulletin & Review*, 10, 730-737.



- [37] Brackett, M. A. (2003). Conceptualizing and measuring the life-space and its relation to openness to experience. Unpublished doctoral dissertation. University of New Hampshire.
- [38] Broadbent, D. E. (1972). *Decision and stress*. New York: Academic Press.
- [39] Camacho, L. M., & Paulus, P. B. (1995). The role of social anxiousness in group brainstorming. *Journal of Personality and Social Psychology*, 68, 1071–1080.
- [40] Carlsson, I. (2002). Anxiety and flexibility of defense related to high or low creativity. *Creativity Research Journal*, 14, 341–349.
- [41] Carlsson, I., Wendt, P. E., & Risberg, J. (2000). On the neurobiology of creativity. Differences in frontal activity between high and low creative subjects. *Neuropsychologia*, 38(6), 873–885.
- [42] Carnevale, P. J., & Probst, T. M. (1998). Social values and social conflict in creative problem-solving and categorization. *Journal of Personality and Social Psychology*, 74, 1300–1309.
- [43] Carson, S. H., Peterson, J. B., & Higgins, D. M. (2005). Reliability, validity, and factor structure of the creative achievement questionnaire. *Creativity Research Journal*, 17(1), 37–50.
- [44] Carter, OL, Burr, DC, Pettigrew, JD, Wallis, GM, Hasler, F, Vollenweider, FX (2005) Using psilocybin to investigate the relationship between attention, working memory, and the serotonin 1A and 2A receptors. *J Cogn Neurosci* 17: 1497–1508.
- [45] Carvalho, P. F. & Goldstone, R. L. (2014) The benefits of interleaved and blocked study: Different tasks benefit from different schedules of study. *Psychonomic Bulletin & Review*, 20(2), 356–363.
- [46] Chatterjee A, Hamilton RH, Amorapanth PX (2006). Art produced by a patient with Parkinson's disease. *Behavioral Neurology*; 17:105–108.
- [47] Chermahini, S. A., & Hommel, B. (2010). The (b) link between creativity and dopamine: spontaneous eye blink rates predict and dissociate divergent and convergent thinking. *Cognition*, 115(3), 458–465.
- [48] Clore, G. L., Schwarz, N., & Conway, M. (1994). Affective causes and consequences of social information processing. In R. S. Wyer & T. K. Srull (Eds.), *Handbook of social cognition* (Vol. 1, pp. 323–417). Hillsdale, NJ: Erlbaum.
- [49] Cohen, L. M. (1989). A continuum of adaptive creative behaviors. *Creativity Research Journal*, 2, 169–183.
- [50] Colzato LS, Ozturk A and Hommel B (2012) Meditate to create: the impact of focused-attention and open-monitoring training on convergent and divergent thinking. *Front. Psychology* 3:116. doi: 10.3389/fpsyg.2012.00116
- [51] Colzato, L. S., Van Wouwe, N. C., & Hommel, B. (2007). Feature binding and affect: Emotional modulation of visuo-motor integration. *Neuropsychologia*, 45, 440–446.
- [52] Colzato, L. S., Szapora, A., Pannekoek, J. N., Hommel, B. (2013) The impact of physical exercise on convergent and divergent thinking. *Frontiers in Human Neuroscience*, 2013; 7 DOI: 10.3389/fnhum.2013.00824
- [53] Coskun, H. (2000). *The Effects of Outgroup Comparison, Social Context, Intrinsic Motivation, and Collective Identity in Brainstorming Groups*. Unpublished Doctoral Dissertation. University of Texas at Arlington.
- [54] Costa, P. T., & McCrae, R. R. (1985). NEO Personality Inventory–Form R.
- [55] Cropley, A. J. (2000). Defining and measuring creativity: Are creativity tests worth using? *Roeper Review*, 23(2), 72–79.
- [56] Csikszentmihalyi, M. (1990). *Theories of creativity*. The domain of creativity, 190–212.
- [57] Csikszentmihalyi, M. (1997). *Creativity: The Psychology of Discovery and Invention*. New York: Harper.
- [58] Csikszentmihalyi, M. (1999). Implications of a systems perspective for the study of creativity. In R. J. Sternberg (Ed.) *Handbook of Creativity* (pp. 313–335). Cambridge, NY: Cambridge University Press.
- [59] Csikszentmihalyi, M., & Getzels, J. W. (1988). Creativity and problem finding. *The foundations of aesthetics, art, and art education*, 91, 106.
- [60] Davis, G. A., & Rimm, S. B. (1994). *Education of the gifted and talented* (3rd ed.). Needham Heights, MA: Simon & Schuster.
- [61] De Dreu, C. K. W., Nijstad, B. A., Bass, M., Wolsink, I., & Roskes, M. (2012). Working memory benefits creative insight, musical improvisation, and original ideation through maintained task-focused attention. *Personality and Social Psychology Bulletin*, 38, 656–669.

- [62] Dennis, A. R., & Williams, M. L. (2003). Electronic brainstorming: Theory, research, and future directions. In P. B. Paulus, & B. A. Nijstad (Eds.), *Group Creativity: Innovation Through Collaboration* (pp. 160–178). New York: Oxford University Press.
- [63] Denti, L. (2011). *Leadership and Innovation: How and when do Leaders Influence Innovation in R&D Teams*; University of Gothenburg Licentiate in Psychology.
- [64] Derosa, D. M., Smith, C. L., & Hantula, D. A. (2007). The medium matters: Mining the long promised merit of group interaction in creative idea generation tasks in a meta-analysis of the electronic group brainstorming literature. *Computers in Human Behavior*, 23, 1549–1581.
- [65] Diehl, M., & Stroebe, W. (1987). Productivity loss in brainstorming groups: Toward the solution of a riddle. *Journal of Personality and Social Psychology*, 53, 497–509.
- [66] Dietrich, A., & Kanso, R. (2010). A review of EEG, ERP, and neuroimaging studies of creativity and insight. *Psychological bulletin*, 136(5), 822.
- [67] Dollinger, S. J. Need for uniqueness, need for cognition and creativity. (2003). *The Journal of Creative Behavior*, Vol 37(2), 99-116.
- [68] Dollinger, S. J., Dollinger, S. M., & Centeno, L. (2005). Identity and creativity. *Identity*, 5, 315–339.
- [69] Drabant, E. M., Hariri, A. R., Meyer Lindenberg, A., Munoz, K. E., Mattay, V. S., Kolachana, B. S., et al. (2006). Catechol-methyltransferase valsuperscript 1-sup-5-sup-8Met genotype and neural mechanisms related to affective arousal and regulation. *Archives of General Psychiatry*, 63, 1396–1406.
- [70] Dreisbach, G., & Goschke, T. (2004). How positive affect modulates cognitive control: Reduced perseveration at the cost of increased distractibility. *Journal of Experimental Psychology: Learning, Memory, and Cognition*, 30, 343–353.
- [71] Eindhoven, J. E., & Vinacke, W. E. (1952). Creative processes in painting. *Journal of General Psychology*, 47, 165–179.
- [72] Ellamil, M., Dobson, C., Beeman, M., & Christoff, K. (2012). Evaluative and generative modes of thought during the creative process. *Neuroimage*, 59(2), 1783-1794.
- [73] Erickson, K. I., Voss, M. W., Prakash, R. S., Basak, C., Szabo, A., et al. (2011). Exercise training increases size of hippocampus and improves memory. *The Proceedings of the National Academy of Sciences* 108, 7 3017–3022 doi:10.1073/pnas.1015950108
- [74] Faust-Socher, A., Kenett, Y. N., Cohen, O. S., Hassin-Baer, S., & Inzelberg, R. (2014). Enhanced Creative Thinking under Dopaminergic Therapy in Parkinson's Disease. *Annals of Neurology*.
- [75] Feist, G. J. (1998). A meta-analysis of personality in scientific and artistic creativity. *Personality and Social Psychology Review*, 2(4), 290-309.
- [76] Fiedler, K. (2000). Toward an integrative account of affect and cognition phenomena using the BIAS computer algorithm. In J. P. Forgas (Ed.), *Feeling and thinking: The role of affect in social cognition* (pp. 223–252). New York: Cambridge University Press.
- [77] Fink, A., & Neubauer, A. C. (2006). EEG alpha oscillations during the performance of verbal creativity tasks: Differential effects of sex and verbal intelligence. *International Journal of Psychophysiology*, 62(1), 46-53.
- [78] Fink, A., Graif, B., & Neubauer, A. C. (2009). Brain correlates underlying creative thinking: EEG alpha activity in professional vs. novice dancers. *NeuroImage*, 46(3), 854-862.
- [79] Finke, R. A., Ward, T. B., & Smith, S. M. (1992). *Creative cognition: Theory, research, and applications*. Cambridge, MA: MIT Press.
- [80] Flaherty, A. W. (2005). Frontotemporal and dopaminergic control of idea generation and creative drive. *Journal of Comparative Neurology*, 493(1), 147-153.
- [81] Florida, R. (2003). Entrepreneurship, creativity, and regional economic growth. *The emergence of entrepreneurship policy*, 39-58.
- [82] Funder, D. C. (2001). *The personality puzzle*. New York: Norton.
- [83] Gabora, L. & Kaufman, S. (2010). Evolutionary perspectives on creativity. In (J. Kaufman & R. Sternberg, Eds.) *Cambridge Handbook of Creativity*. (pp. 279-300). Cambridge UK: Cambridge University Press.



- [84] Gabora, L. & Tseng, S. (2014). Computational evidence that self-regulation of creativity is good for society. Proceedings of the 36th Annual Meeting of the Cognitive Science Society. Held July 23-26, Quebec City. Houston TX: Cognitive Science Society.
- [85] Gabora, L. (2005). Creative thought as a non-Darwinian evolutionary process. *Journal of Creative Behavior*, 39, 262–283. doi:10.1002/j.2162-6057.2005.tb01261.x.
- [86] Gabora, L., O'Connor, B., & Ranjan, A. (2012). The recognizability of individual creative styles within and across domains. *Psychology of Aesthetics, Creativity, and the Arts*, 6(4), 351-360.
- [87] Gardner, H. (1993). *Creating minds*. New York: Basic Books.
- [88] Gasper, K. (2003). When necessity is the mother of invention: Mood and problem-solving. *Journal of Experimental Social Psychology*, 39, 248–262.
- [89] Geen, R. G. (1989). Alternative conceptions of social facilitation. In P. B. Paulus (Ed.), *Psychology of Group Influence* (2nd edn, pp. 15–51). Hillsdale, NJ: Erlbaum.
- [90] George, J. M., & Brief, A. P. (1996). Motivational agendas in the workplace: The effects of feelings on focus of attention and work motivation. In B. M. Staw & L. L. Cummings (Eds.), *Research in organizational behavior: An annual series of analytical essays and critical reviews* (Vol. 18, pp. 75–109). Greenwich, CT: JAI Press.
- [91] George, J. M., & Zhou, J. (2007). Dual tuning in a supportive context: Joint contributions of positive mood, negative mood, and supervisory behaviors to employee creativity. *Academy of Management Journal*, 50, 605–622.
- [92] Gero, J. S. (2000). Computational models of innovative and creative design processes. *Technological forecasting and social change*, 64(2), 183-196.
- [93] Gilhooly, K.J., Fioratou, E., Anthony, S.H., & Wynn, V. (2007). Divergent thinking: strategies and executive involvement in generating novel uses for familiar objects. *Br. J. Psychol.* 98, 611–625.
- [94] Glade, M. J. (2010). Caffeine – Not just a stimulant. *Nutrition*, 26(10):932-8. doi: 10.1016/j.nut.2010.08.004.
- [95] Glick, P., Fiske, S. T., Mladinic, A., Saiz, J, Abrams, D., Masser, B., et al. (2000). Beyond prejudice as simple antipathy: Hostile and benevolent sexism across cultures. *Journal of Personality and Social Psychology*, 79, 763-775.
- [96] Goel, V. (2014) Creative brains: Designing in the real world. *Frontiers in Human Neuroscience*, April, doi: 10.3389/fnhum.2014.00241
- [97] Goel, V., & Vartanian, O. (2005). Dissociating the roles of right ventral lateral and dorsal lateral prefrontal cortex in generation and maintenance of hypotheses in set-shift problems. *Cerebral Cortex*, 15(8), 1170-1177.
- [98] Gong, G., He, Y., Evans, A.C. (2011). Brain connectivity: gender makes a difference. *Neuroscientist*, 17, pp. 575–591.
- [99] Gong, G., Rosa-Neto, P., Carbonell, F., Chen, Z.J., He, Y., Evans, A. C. (2009). Age-and gender-related differences in the cortical anatomical network. *J. Neurosci.*, 29, pp. 15684–15693.
- [100] Grant, E. R., & Spivey, M. J. (2003). Eye movements and problem-solving guiding attention guides thought. *Psychological Science*, 14(5), 462-466.
- [101] Grawitch, M. J., Munz, D. C., & Kramer, T. J. (2003). Effects of member mood states on creative performance in temporary workgroups. *Group Dynamics: Theory, Research, and Practice*, 7, 41–54.
- [102] Gray, J. A. (1982). *Precis of the neuropsychology of anxiety: An enquiry into the functions of the septo-hippocampal system*. *Behavioral and Brain Sciences*, 5, 469–534.
- [103] Gray, P., and Chanoff, D. (1986). Democratic schooling: What happens to young people who have charge of their own education? *American Journal of Education*, 94, 2, 182-213.
- [104] Green, A. E., Kraemer, D. J., Fugelsang, J. A., Gray, J. R., & Dunbar, K. N. (2012). Neural correlates of creativity in analogical reasoning. *Journal of Experimental Psychology: Learning, Memory, and Cognition*, 38(2), 264.
- [105] Green, D. P., Goldman, S. L., & Salovey, P. (1993). Measurement error masks bipolarity in affect ratings. *Journal of Personality and Social Psychology*, 64, 1029–1041.

- [106] Gregory, E., Hardiman, M., Yarmolinsky, J., Rinne, L., & Limb, C. (2013) Building Creative Thinking in the Classroom: From Research to Practice, *International Journal of Educational Research*, 62, 43-50.
- [107] Guilford, J. P. (1967). Creativity: Yesterday, today and tomorrow. *The Journal of Creative Behavior*, 1(1), 3-14.
- [108] Guilford, J.P. (1950). Creativity. *American Psychologist*, 5, 444-454.
- [109] Guncer, B., & Oral, G. (1993) Relationships between creativity and non-conformity to school discipline as perceived by teachers of Turkish elementary school children by controlling their grade and sex. *Journal of Instructional Psychology*, 20, 208-214.
- [110] Haslam, S. A., Adarves-Yorno, I. Postmes, T., Jans, L. (2013) The collective origins of valued originality: A social identity approach to creativity. *Personality and Social Psychology Review*, Vol 17(4), Nov, 2013. pp.384-401.
- [111] Hébert, T. P., Cramond, B., Neumeister, K. L. S., Millar, G., & Silvian, A. F. (2002). E. Paul Torrance: His life, accomplishments, and legacy. Storrs: The University of Connecticut, The National Research Center on the Gifted and Talented (NRC/GT).
- [112] Hemlin, S., Allwood, C. M., & Martin, B. R. (2008). Creative knowledge environments. *Creativity Research Journal*, 20, 196-210.
- [113] Hirt, E. R., Levine, G. M., McDonald, H. E., Melton, R. J., & Martin, L. (1997). The role of mood in quantitative and qualitative aspects of performance: Single or multiple mechanisms? *Journal of Personality and Social Psychology*, 33, 602-629.
- [114] Hirt, E. R., Melton, R. J., McDonald, H. E., & Harackiewicz, J. M. (1996). Processing goals, task interest, and the mood-performance relationship: A mediational analysis. *Journal of Personality and Social Psychology*, 71, 245-261.
- [115] Hockenbury, D. H. & Hockenbury, S. E. (2009) *Coast Telecourse Guide for Psychology*. New York: Macmillan.
- [116] Howard-Jones, P. A. (2008). *Fostering creative thinking: co-constructed insights from neuroscience and education*. Discussions in Education Series, University of Bristol, UK.
- [117] Howard-Jones, P. A., Blakemore, S. J., Samuel, E. A., Summers, I. R., & Claxton, G. (2005). Semantic divergence and creative story generation: An fMRI investigation. *Cognitive Brain Research*, 25(1), 240-250.
- [118] Hülsheger, U. R., Anderson, N., & Salgado, J. F. (2009). Team-level predictors of innovation at work: A comprehensive meta-analysis spanning three decades of research. *Journal of Applied Psychology*, 94, 1128-1145.
- [119] Hunsaker, S. L., & Callahan, C. M. (1995). Creativity and giftedness: Published instruments uses and abuses. *Gifted Child Quarterly*, 39, 110-114.
- [120] Hunter, S.T., Bedell, K. E. & Mumford, M.D. (2007). Climate for creativity: A quantitative review. *Creativity Research Journal*, 19,1, 69-90.
- [121] Ingalhalikar, M., Smith, A., Parker, D., Satterthwaite, T.D., Elliott, M.A., Ruparel, K., Hakonarson, H., Gur, R.E., Gur, R.C., Verma, R. (2013). Sex differences in the structural connectome of the human brain. *Proceedings of the National Academy of Sciences*.
- [122] Inzelberg R. (2013). The awakening of artistic creativity and Parkinson's disease. *Behav Neurosci*: 127:256-261.
- [123] Isen, A. M., & Baron, R. A. (1991). Positive affect as a factor in organizational behavior. *Research in Organizational Behavior*, 13, 1-53.
- [124] Ivcevic, Z., & Mayer, J. D. (2009). Mapping dimensions of creativity in the life-space. *Creativity Research Journal*, 21(2-3), 152-165.
- [125] Ivcevic, Z., Brackett, M. A., & Mayer, J. D. (2007). Emotional intelligence and emotional creativity. *Journal of Personality*, 75, 199-236. doi:10.1111/j.1467-6494.2007.00437.x.
- [126] Jaeggi, S., Buschkuhl, M., Jonides, J., Perrig, W. (2008) Improving fluid intelligence with training on working memory. *PNAS*. doi: 10.1073/pnas.0801268105
- [127] Jehn, K. A. (1995). A multimethod examination of the benefits and detriments of intragroup conflict. *Administrative Science Quarterly*, 40, 256-282.
- [128] Jia, L., Hirt, E. R. Hirt, & Karpen, S. C. (2009) Lessons from a Faraway Land: The Effect of Spatial Distance on Creative Cognition *Journal of Experimental Social Psychology*, 45 (5), 1127-1131.



- [129] Johnson, A. S., & Fishkin, A. S. (1999). Assessment of cognitive and affective behaviors related to creativity. In A. S. Fishkin, B. Cramond, & P. Olszewski-Kubilius (Eds.), *Investigating creativity in youth: Research and methods* (pp. 265–306). Cresskill, NJ: Hampton.
- [130] Jung-Beeman, M., Bowden, E. M., Haberman, J., Frymiare, J. L., Arambel-Liu, S., Greenblatt, R., ... & Kounios, J. (2004). Neural activity when people solve verbal problems with insight. *PLoS biology*, 2(4), e97.
- [131] Karau, S. J., & Williams, K. D. (1993). Social loafing: A meta-analytic review and theoretical integration. *Journal of Personality and Social Psychology*, 65, 681–706.
- [132] Karimi, Z., Windman, S., Gumturkun, O., & Abraham, A. (2007). Insight problem-solving in individuals with high versus low schizotypy. *Journal of Research in Personality* 01/2007; DOI: 10.1016/j.jrp.2006.03.008
- [133] Kaufman, J. C., & Beghetto, R. A. (2009). Beyond big and little: The four c model of creativity. *Review of General Psychology*, 13(1), 1.
- [134] Kaufman, S. B. (2011). Why daydreamers are more creative. *Creative people daydream more, even while concentrating*. *Psychology Today*, February 27, 2011
- [135] Kaufmann, G., & Vosburg, S. K. (1997). "Paradoxical" mood effects on creative problem-solving. *Cognition and Emotion*, 11, 151–170.
- [136] Kim, K. H. (2011) The Creativity Crisis: The Decrease in Creative Thinking Scores on the Torrance Tests of Creative Thinking. *Creativity Research Journal*, 23:4, 285-295, DOI: 10.1080/10400419.2011.627805.
- [137] Kim, S. H., Vincent, L. C., & Goncalo, J. A. (2012). Outside Advantage: Can Social Rejection Fuel Creative Thought? *Journal of Experimental Psychology: General*, 2012; DOI: 10.1037/a0029728
- [138] King, L. A., Walker, L. M., & Broyles, S. J. (1996). Creativity and the five-factor model. *Journal of Research in Personality*, 30(2), 189-203.
- [139] Knoblich, G., Ohlsson, S., & Raney, G. E. (2001). An eye movement study of insight problem-solving. *Memory & Cognition*, 29(7), 1000-1009.
- [140] Koh, T. S., & Lee, S. C. (Eds.). (2008). *Information Communication Technology in Education: Singapore's ICT Masterplans, 1997-2008*. World Scientific Publishing.
- [141] Kounios, J., & Beeman, M. (2009). The Aha! Moment the cognitive neuroscience of insight. *Current directions in psychological science*, 18(4), 210-216.
- [142] Kounios, J., Frymiare, J., Bowden, E., Fleck, J., Subramaniam, K., Parrish, T., & Jung-Beeman, M. (2006). The prepared mind: Neural activity prior to problem presentation predicts subsequent solution by sudden insight. *Psychological Science*, 17, 882–891. doi:10.1111/j.1467-9280.2006.01798.x.
- [143] Kröger, S., Rutter, B., Stark, R., Windmann, S., Hermann, C., & Abraham, A. (2012). Using a shoe as a plant pot: neural correlates of passive conceptual expansion. *Brain research*, 1430, 52-61.
- [144] Kühn, S., Ritter, S. M., Müller, B. C. N., van Baaren, R. B., Brass, M. and Dijksterhuis, A. (2014), The Importance of the Default Mode Network in Creativity—A Structural MRI Study. *The Journal of Creative Behavior*, 48: 152–163. doi: 10.1002/jocb.45
- [145] Kulisevsky J, Pagonabarraga J, Martinez-Corral M. (2009). Changes in artistic style and behaviour in Parkinson's disease: dopamine and creativity. *J Neurol*; 256:816–819.
- [146] Lee, C. S., Theriault, D. J. and Linderholm, T. (2012), On the Cognitive Benefits of Cultural Experience: Exploring the Relationship between Studying Abroad and Creative Thinking. *Appl. Cognit. Psychol.*, 26: 768–778. doi: 10.1002/acp.2857.
- [147] Leung, A. K., & Chiu, C.-Y. (2010). Multicultural experience, idea receptiveness, and creativity. *Journal of Cross-Cultural Psychology*, 41, 723–741. DOI:10.1177/0022022110361707
- [148] Leung, A. K., Maddux, W. W., Galinsky, A. D., & Chiu, C.-Y. (2008). Multicultural experience enhances creativity. *American Psychologist*, 63(3), 169–181. DOI:10.1037/0003-066X.63.3.169
- [149] Lhommée, E., Batir, A., Quesada, J. L., Ardouin, C., Fraix, V., Seigneuret, E., ... & Krack, P. (2014). Dopamine and the biology of creativity: lessons from Parkinson's disease. *Frontiers in neurology*, 5.
- [150] Li, W., Li, X., Huang, L., Kong, X., Yang, W., Wei, D., Li, J., Chen, H., Zhang, Q., Qui, J., & Liu, J. 2014. Brain Structure Links Trait Creativity to Openness to Experience. *Social Cognitive and Affective Neuroscience*, March.
- [151] Lillard, A. S., Lerner, M. D., Hopkins, E. J., Dore, R. A., Smith, E. D., & Palmquist, C. M. (2013). The impact of pretend play on children's development: The state of the evidence. *Psychological Bulletin*, 139(1), 1-34.
- [152] Lubart, T. I. (1994). Creativity. In R. J. Sternberg (Ed.), *Thinking and problem-solving* (pp. 290–332). San Diego, CA: Academic.

- [153] Lubart, T. I. (2010). Cross-cultural perspectives on creativity. In J.C. Kaufman & R. J. Sternberg (Eds.) *The Cambridge Handbook of Creativity* (pp 265-278). Cambridge University Press.
- [154] Lucas, B., Claxton, G., and Spencer, E. (2013), "Progression in Student Creativity in School: First Steps Towards New Forms of Formative Assessments", OECD Education Working Papers, No. 86, OECD Publishing. <http://dx.doi.org/10.1787/5k4dp59msdwk-en>
- [155] Ludwi, A. M. (1995) *The Price of Greatness: Resolving the Creativity and Madness Controversy*, 1995, Gilford press.
- [156] Luo, J., & Knoblich, G. (2007). Studying insight problem-solving with neuroscientific methods. *Methods*, 42(1), 77-86.
- [157] Luo, J., Niki, K., & Philips, S. (2004). Neural correlates of the Aha! reaction. *NeuroReport*, 15, 2013–2018. doi:10.1097/00001756-200409150-00004.
- [158] Lyubomirsky, S., King, L., & Diener, E. (2005). The benefits of frequent positive affect: Does happiness lead to success? *Psychological Bulletin*, 131, 803–855.
- [159] MacKinnon, D. W. (1962). The nature and nurture of creative talent. *American psychologist*, 17(7), 484.
- [160] Madjar, N., & Oldham, G. R. (2002). Preliminary tasks and creative performance on a subsequent task: Effects of time on preliminary tasks and amount of information about the subsequent task. *Creativity Research Journal*, 14, 239–251.
- [161] Mannix, E., & Neale, M. A. (2005). What differences make a difference? The promise and reality of diverse teams in organizations. *Psychological Science in the Public Interest*, 6, 31–55.
- [162] Masmoudi, S., & Charaf, I. (2013) *Créativité verbale et valence émotionnelle: «Je deviens plus créatif quand je vois un mot positif ! »* *Revue européenne de psychologie appliquée*, 63 (4), 219–229
- [163] Mayer, J. D. (2004). A classification system for the data of personality psychology and adjoining fields. *Review of General Psychology*, 8, 208–219.
- [164] Mayer, J. D., Carlsmith, K. M., & Chabot, H. F. (1998). Describing the person's external environment: Conceptualizing and measuring the life-space. *Journal of Research in Personality*, 32, 253–296.
- [165] McCrae, R. R. (1987). Creativity, divergent thinking, and openness to experience. *Journal of personality and social psychology*, 52(6), 1258.
- [166] McGrew, K. S. (2005). The Cattell-Horn-Carroll theory of cognitive abilities. In D. P. Flanagan & P. L. Harrison (Eds.), *Contemporary intellectual assessment: Theories, tests, and issues* (2nd ed., pp. 136–181). New York, NY: Guilford.
- [167] Mednick, S. A. (1962). The associative basis of the creative process. *Psychological Review*, 69, 220–232. doi:10.1037/h0048850.
- [168] Milgram, R. M., & Rabkin, L. (1980). Developmental test of Mednick's associative hierarchies of original thinking. *Developmental Psychology*, 16, 157–158. doi:10.1037/0012-1649.16.2.157.
- [169] MOE (Ministry of Education), Singapore (1997), *Shaping our future: Thinking schools, Learning Nation*, speech by Prime Minister Goh Chok Tong at the 7th International Conference on Thinking on 2 June 1997, <http://www.moe.gov.sg/media/speeches/1997/020697.htm>
- [170] MOE (Ministry of Education), Singapore (2014), *MOE Subject Syllabuses*, <http://www.moe.gov.sg/education/syllabuses>.
- [171] Moseley, D., Baumfield, V., Elliott, J., Gregson, M., Higgins, S., Miller, J., Newton, D. (2005). «De Bono's lateral and parallel thinking tools», in ed. Moseley, David: *Frameworks for Thinking*. Cambridge University Press.
- [172] Mullen, B., Johnson, C., & Salas, E. (1991). Productivity loss in brainstorming groups: A metaanalytic integration. *Basic and Applied Social Psychology*, 12, 3–23.
- [173] Mumford, M. D. (2003). Where have we been, where are we going? Taking stock in creativity research. *Creativity Research Journal*, 15, 107–120.
- [174] Mumford, M. D., Mobley, M. I., Uhlman, C. E., Reiter-Palmon, R., & Doares, L. M. (1991). Process analytic models of creative capacities. *Creativity Research Journal*, 4, 91–122.
- [175] Mumford, M. D., Scott, G. M., Gaddis, B., & Strange, J. M. (2002). Leading creative people: Orchestrating expertise and relationships. *The Leadership Quarterly*, 13, 705–730.
- [176] Nassif, C., & Quevillon, R. (2008). The development of a preliminary creativity scale for the MMPI-2: the C scale. *Creativity Research Journal*, 20(1), 13-20.



- [177] Nieuwenhuis, S., Aston-Jones, G., & Cohen, J. D. (2005). Decision making, the P3, and the locus coeruleus–norepinephrine system. *Psychological Bulletin*, 131, 510–532.
- [178] Nijstad, B., & Stroebe, W. (2006). How the group affects the mind: A cognitive model of idea generation in groups. *Personality and Social Psychology Review*, 10, 186–213.
- [179] Niu, W., & Sternberg, R. J. (2006). The philosophical roots of western and eastern conceptions of creativity. *Journal of Theoretical and Philosophical Psychology*, 26, 18–38.
- [180] Nusbaum, E. C., & Silvia, P. J. (2011). Are intelligence and creativity really so different? Fluid intelligence, executive processes, and strategy use in divergent thinking. *Intelligence*, 39, 36–45. doi:10.1016/j.intell.2010.11.002.
- [181] O'Hara, L. A., & Sternberg, R. J. (2000–2001). It doesn't hurt to ask: Effects of instructions to be creative, practical, or analytical on essay—writing performance and their interaction with students' thinking styles. *Creativity Research Journal*, 13, 197–210.
- [182] O'Quin, K., & Derks, P. (1997). Humor and creativity: A review of the empirical literature. In M. Runco (Ed.), *Creativity Research Handbook*, vol. 1, pp. 227-256.
- [183] Ochse, R. (1990). *Before the gates of excellence: The determinants of creative genius*. New York: Cambridge University Press.
- [184] OECD (2014) PISA 2012 Results: Creative problem-solving: Students's Skills in Tackling Real-Life Problems (Vol. V), PISA, OECD Publishing. DOI: 10.1789/9789264208070-en.
- [185] Onarheim, B., & Friis-Olivarius, M. (2013). Applying the neuroscience of creativity to creativity training. *Frontiers in human neuroscience*, 7.
- [186] Osborn, A. F. (1957). *Applied Imagination* (1st edn). New York: Scribner.
- [187] Osborn, M. (2006). Changing the context of teachers' work and professional development: A European perspective. *International journal of educational research*, 45(4), 242-253.
- [188] Parnes, S. J., & Meadow, A. (1959). Effects of "brainstorming" instructions on creative problem-solving by trained and untrained subjects. *Journal of Educational Psychology*, 50, 171–176.
- [189] Parnes, S. J., & Noller, R. B. (1972). Applied creativity: The creative studies project. *The Journal of Creative Behavior*, 6(3), 164-186.
- [190] Paulus, P. B., & Brown, V. (2003). Enhancing ideational creativity in groups: Lessons from research on brainstorming. In P. B. Paulus, & B. A. Nijstad (Eds.), *Group Creativity: Innovation Through Collaboration* (pp. 110–137). New York: Oxford University Press.
- [191] Paulus, P. B., & Brown, V. R. (2007). Toward More Creative and Innovative Group Idea Generation: A Cognitive Social Motivational Perspective of Brainstorming. *Social and Personality Psychology Compass*, 1(1), 248-265.
- [192] Paulus, P. B., & Dzindolet, M. T. (1993). Social influence processes in group brainstorming. *Journal of Personality and Social Psychology*, 64, 575–586.
- [193] Paulus, P. B., Larey, T. S., Putman, V. L., Leggett, K. L., & Roland, E. J. (1996). Social influence processes in computer brainstorming. *Basic and Applied Social Psychology*, 18, 3–14.
- [194] Phelan, J. E., Moss-Racusin, C. E. & Rudman, L. A. (2008). Competent yet out in the cold: shifting criteria for hiring reflect backlash toward agentic women. *Psychology of Women Quarterly*, 32, 4, 406–413.
- [195] Plucker, J. A., & Renzulli, J. S. (1999). Psychometric approaches to the study of human creativity. *Handbook of creativity*, 35-61.
- [196] Plucker, J. A., Beghetto, R. A., & Dow, G. T. (2004). Why isn't creativity more important to educational psychologists? Potentials, pitfalls, and future directions in creativity research. *Educational Psychologist*, 39(2), 83-96.
- [197] Polman, E., & Emich, K. J. (2011). Decisions for Others Are More Creative Than Decisions for the Self. *Personality and Social Psychology Bulletin*, 37(4), 492-501.
- [198] Posner, J., Russell, J. A., & Peterson, B. S. (2005). The circumplex model of affect: An integrative approach to affective neuroscience, cognitive development, and psychopathology. *Development and Psychopathology*, 17, 715–734.
- [199] Ranjan, A. & Gabora, L. (2012). Creative ideas for actualizing student potential. In (H. Snyder, M. Gregerson, & J. Kaufman, Eds.) *Teaching creatively* (pp. 119-132). Berlin: Springer. <http://arxiv.org/abs/1310.3010>

- [200] Rhodes, M. (1961/1987). An analysis of creativity. In S. G. Isaksen (Ed.), *Frontiers of creativity research: Beyond the basics* (pp. 216–222). Buffalo, NY: Bearly.
- [201] Ricchiardelli, L. (1992) Creativity and Bilingualism. *The Journal of Creative Behavior*, 26 (4), 242–254. DOI: 10.1002/j.2162-6057.1992.tb01183.x
- [202] Richards, R. (1990). Everyday creativity, eminent creativity, and health: “Afterview” for CRJ issues on creativity and health. *Creativity Research Journal*, 3, 300–326.
- [203] Richards, R., Kinney, D. K., Benet, M., & Merzel, A. P. C. (1988). Assessing everyday creativity: Characteristics of the Lifetime Creativity Scales and validation with three large samples. *Journal of Personality and Social Psychology*, 54, 476–485.
- [204] Ritter, S. M., Damian, R. I., Simonton, D. K., van Baaren, R. B., Strick, M., Derks, J., & Dijksterhuis, A. (2012). Diversifying experiences enhance cognitive flexibility. *Journal of Experimental Social Psychology*, 48, 961-964.
- [205] Robbins, T.W. (1984). Cortical noradrenaline, attention, and arousal. *Psychological Medicine*, 14, 13–21. Chamberlain, S. R., Muller, U., Blackwell, A. D., Robbins, T.W., & Sahakian, B. J. (2006). Noradrenergic modulation of working memory and emotional memory in humans. *Psychopharmacology*, 188, 387–407.
- [206] Runco, M. A. & Prizker, S. 1999. *The Encyclopedia of Creativity*. London: Academic Press
- [207] Runco, M. A. (1986). Flexibility and originality in children's divergent thinking. *Journal of Psychology: Interdisciplinary and Applied*, 120, 345–352. doi:10.1080/00223980.1986.9712632.
- [208] Runco, M. A. (1996). Personal creativity: Definition and developmental issues. *New Directions for Child Development*, 72, 3–30.
- [209] Runco, M. A. (2004). Everyone has creative potential. In R. J. Sternberg, E. L. Grigorenko, & J. L. Singer (Eds.), *Creativity: From potential to realization*. (pp. 21–30). Washington, DC: American Psychological Association.
- [210] Runco, M. A., & Acar, S. (2012). Divergent thinking as an indicator of creative potential. *Creativity Research Journal*, 24(1), 66-75.
- [211] Runco, M. A., & Jaeger, G. J. (2012). The standard definition of creativity. *Creativity Research Journal*, 24(1), 92-96.
- [212] Rutter, B., Kröger, S., Stark, R., Schweckendiek, J., Windmann, S., Hermann, C., & Abraham, A. (2012). Can clouds dance? Neural correlates of passive conceptual expansion using a metaphor processing task: implications for creative cognition. *Brain and cognition*, 78(2), 114-122.
- [213] Salvi, C., Bricolo, E., Franconeri, S., Kounios, J. & Beeman, M. (unpublished). Shutting Out Visual Input Facilitates Creative Insight.
- [214] Sawyer, R. K., John-Steiner, V., Moran, S., Sternberg, R., Feldman, D. H. (2003). Csikszentmihalyi, M., Nakamura, J.. *Creativity and development*. New York: Oxford University Press.
- [215] Schrag A, Trimble M. (2001). Poetic talent unmasked by treatment of Parkinson's disease. *Mov Disord*; 16:1175–1176.
- [216] Schwarz, N., & Bless, H. (1991). Happy and mindless, but sad and smart? The impact of affective states on analytic reasoning. In J. P. Forgas (Ed.), *Emotion and social judgments* (pp. 55–71). Elmsford, NY: Pergamon Press.
- [217] Schwarz, N., & Clore, G. L. (1988). How do I feel about it? The informative function of affective states. In K. Fiedler & J. Forgas (Eds.), *Affect, cognition, and social behavior* (pp. 44–62). Toronto, Ontario, Canada: Hogrefe.
- [218] Schwingenschuh P, Katschnig P, Saurugg R, et al. (2010). Artistic profession: a potential risk factor for dopamine dysregulation syndrome in Parkinson's disease? *Mov Disord*; 25:493–496.
- [219] Scott, G., Leritz, L. E., & Mumford, M. D. (2004). The effectiveness of creativity training: A quantitative review. *Creativity Research Journal*, 16(4), 361-388.
- [220] Scott, W A (1962). “Cognitive complexity and cognitive flexibility”. *American Sociological Association* 25: 405–414. doi:10.2307/2785779.
- [221] Sen, A. K., & Hagtvet, K. (1993). Correlations among creativity, intelligence, personality, and academic achievement. *Perceptual and Motor Skills*, 77(2), 497-498.
- [222] Sessa, B. (2008). Is it time to revisit the role of psychedelic drugs in enhancing human creativity?. *Journal of Psychopharmacology*, 22(8), 821-827.



- [223] Silvia, P. J., Winterstein, B. P., Willse, J. T., Barona, C. M., Cram, J. T., Hess, K. I., Martinez, J. L., & Richard, C. A. (2008). Assessing creativity with divergent thinking tasks: Exploring the reliability and validity of new subjective scoring methods. *Psychology of Aesthetics, Creativity, and the Arts*, 2, 68–85. doi:10.1037/1931-3896.2.2.68.
- [224] Simonton, D. K. (1994). *Greatness: Who makes history and why*. New York: Guilford Press.
- [225] Simonton, D. K. (1997). Creative productivity: A predictive and explanatory model of career trajectories and landmarks. *Psychological Review*, 104, 66–89.
- [226] Simonton, D. K. (1999). *The Origins of Genius: Darwinian Perspectives on Creativity*. New York: Oxford University Press.
- [227] Sio, U. N., & Ormerod, T. C. (2009). Does incubation enhance problem-solving? A metaanalytic review. *Psychological Bulletin*, 135, 94–120.
- [228] Soriano de Alencar, E. M. L., Bruno-Faria, M. & de Souza Fleith, D. (2014). *Theory and Practice of Creativity Measurement*. Waco, Texas : Proofrock.
- [229] Starchenko, M., Bechtereva, N., Pakhomov, S., & Medvedev (2003). Study of the brain organization of creative thinking. *Human Physiology*, 29, 652–653. doi:10.1023/A:1025836521833.
- [230] Stavridou, A., & Furnham, A. (1996). The relationship between psychoticism, trait-creativity and the attentional mechanism of cognitive inhibition. *Personality and Individual Differences*, 21(1), 143-153.
- [231] Staw, B. M., Sandelands, L. E., & Dutton, J. E. (1981). Threat-rigidity effects in organizational behavior: A multilevel analysis. *Administrative Science Quarterly*, 26, 501–524.
- [232] Sternberg, R. J. (1985). *Beyond IQ: A triarchic theory of human intelligence*. New York: Cambridge University Press.
- [233] Sternberg, R. J. (1997). *Successful intelligence*. New York: Plume.
- [234] Sternberg, R. J. (2006). The nature of creativity. *Creativity Research Journal*, 18(1), 87-98.
- [235] Sternberg, R. J. (Ed.). (1988). *The nature of creativity: Contemporary psychological perspectives*. CUP Archive.
- [236] Sternberg, R. J. (Ed.). (1999). *Handbook of creativity*. New York: Cambridge University Press.
- [237] Sternberg, R. J., & Grigorenko, E. L. (1995). Styles of thinking in school. *European Journal for High Ability*, 6(2), 201–219.
- [238] Sternberg, R. J., & Lubart, T. I. (1991). An investment theory of creativity and its development. *Human development*, 34(1), 1-31.
- [239] Sternberg, R. J., & Lubart, T. I. (1992). Creativity: Its nature and assessment. *School Psychology International*, 13(3), 243–253.
- [240] Sternberg, R. J., & Lubart, T. I. (1995). *Defying the crowd: Cultivating creativity in a culture of conformity*. Free Press.
- [241] Sternberg, R. J., & Lubart, T. I. (1996). Investing in creativity. *American psychologist*, 51(7), 677
- [242] Sternberg, R. J., Kaufman, J. C., & Pretz, J. E. (2002). *The creativity conundrum*. Philadelphia: Psychology Press.
- [243] Sternberg, R.J., & Davidson, J.E. (Eds.). (1995). *The nature of insight*. Cambridge, MA: MIT Press.
- [244] Stroebe, W., & Diehl, M. (1994). Why groups are less effective than their members: On productivity losses in idea generating groups. In W. Stroebe, & M. Hewstone (Eds.), *European Review of Social Psychology* (Vol. 5, pp. 271–303). London: Wiley.
- [245] Swartz, J. D. (1988). Torrance Tests of Creative Thinking. In D. J. Keyser & R. C. Sweetland (Eds.), *Test Critique Vol. 7* (pp. 619–622). Kansas, MS: Test Corporation of America.
- [246] Takeuchi H, Taki Y, Hashizume H, Sassa Y, Nagase T, Nouchi R, Kawashima R. (2011). Failing to deactivate: the association between brain activity during a working memory task and creativity. *Neuroimage*. 5;55(2):681-7. doi: 10.1016/j
- [247] Thayer, R. (1989). *The biopsychology of mood and arousal*. New York: Oxford University Press.
- [248] Torrance, E. P. (1966). *Torrance tests of creative thinking: Normstechnical manual* (Research ed.). Princeton, NJ: Personnel Press.
- [249] Torrance, E. P. (1971). Are the Torrance Tests of Creative Thinking biased against or in favor of “disadvantaged” groups? *Gifted Child Quarterly*, 15, 75–80.
- [250] Torrance, E. P. (1974). *Norms-technical manual: Torrance Tests of Creative Thinking*. Lexington, MA: Ginn & Co.

- [251] Torrance, E. P. (1974). *The Torrance Tests of Creative Thinking-Norms-Technical Manual Research Edition-Verbal Tests, Forms A and B- Figural Tests, Forms A and B*. Princeton, NJ: Personnel Press.
- [252] Torrance, E. P. (1990). Experiences in developing creativity measures: Insights, discoveries, decisions. Unpublished Manuscript, Torrance Center for Creative Studies and Talent Development, University of Georgia, Athens, GA.
- [253] Torrance, E. P., & Torrance, P. (1972). Combining creative problem-solving with creative expressive activities in the education of disadvantaged young people. *Journal of Creative Behavior*, 6(1), 1–10.
- [254] Treffinger, D. J. (1985). Review of the Torrance Tests of Creative Thinking. In J. V. Mitchell Jr. (Ed.), *The ninth mental measurements yearbook* (pp. 1632–1634). Lincoln: University of Nebraska, Buros Institute of Mental Measurements.
- [255] Tsai K.C. (2013) Examining gender differences in creativity. *The International Journal of Social Sciences*, 13, 1, 115-122.
- [256] Unsworth, N. (2010). Interference control, working memory capacity, and cognitive abilities: A latent variable analysis. *Intelligence*, 38, 255–267. doi:10.1016/j.intell.2009.12.003.
- [257] Urban, K. K. (2005). Assessing Creativity: The Test for Creative Thinking-Drawing Production (TCT-DP). *International Education Journal*, 6(2), 272-280.258.
- [258] Urban, K. K., & Jellen, H. G. (1996). Test for creative thinking-drawing production manual.
- [259] Usher, M., Cohen, J. D., Servan Schreiber, D., Rajkowski, J., & Aston Jones, G. (1999). The role of locus coeruleus in the regulation of cognitive performance. *Science*, 283, 549–554.
- [260] Vartanian, O. (2009). Variable attention facilitates creative problem-solving. *Psychology of Aesthetics, Creativity, and the Arts*, 3, 57–59. doi: 10.1037/a0014781.
- [261] Vartanian, O. (2011). Decision junctures in the creative process. In O. Vartanian & D. R. Mandel (Eds.), *Neuroscience of decision making* (pp. 311–327). New York, NY: Psychology Press.
- [262] Vartanian, O. (2012) Dissociable neural systems for analogy and metaphor: implications for the neuroscience of creativity. *British Journal of Psychology*, 103(3):302-16. doi: 10.1111/j.2044-8295.2011.02073.x. Epub 2011 Oct 3.
- [263] Vygotsky, L. S. (2004). Imagination and creativity in childhood. (M. E. Sharpe, Inc., Trans.). *Journal of Russian and East European Psychology*, 42, 7–97. (Original work published 1967).
- [264] Walker RH, Warwick R, Cercy SP. (2006). Augmentation of artistic productivity in Parkinson's disease. *Mov Disord*; 21:285–286.
- [265] Wallach, M. A., & Kogan, N. (1965). *Modes of thinking in young children: A study of the creativity–intelligence distinction*. New York: Holt, Rinehart, & Winston.
- [266] Ward, T. B., Smith, S. M., & Vaid, J. (Eds.) (1997). *Creative Thought: An Investigation of Conceptual Structures and Processes*. Washington, DC: American Psychological Association.
- [267] Ward, W. C. (1969). Rate and uniqueness in children's creative responding. *Child Development*, 40, 869–878. doi:10.2307/1127195.
- [268] Watson, D., Clark, L. A., & Tellegen, A. (1988). Development and validation of brief measures of positive and negative affect: The PANAS scales. *Journal of Personality and Social Psychology*, 54, 1063–1070.
- [269] Wieth, M. B., & Zacks, R. T. (2011). Time of day effects on problem-solving: When the non-optimal is optimal. *Thinking & Reasoning*, 17(4), 387-401.
- [270] Winner, E. (1996). What Drawings by Atypical Populations Can Tell Us. *Visual Arts Research*, 90-95.
- [271] Witt K, Krack P, Deuschl G.(2006). Change in artistic expression related to subthalamic stimulation. *J Neurol*; 253:955–956.
- [272] Wolfardt, U., & Pretz, J. E. (2001). Individual differences in creativity: Personality, story writing, and hobbies. *European Journal of Personality*, 15(4), 297-310.
- [273] Yerkes, R. M., & Dodson, J. D. (1908). The relation of strength of stimulus to rapidity of habit formation. *Journal of Comparative Neurology and Psychology*, 18, 459–482.
- [274] Kenett, Y.N., Anaki, D., Faust, M. (2014) Investigating the structure of semantic networks in low and high creative persons. *Frontiers in Human Neuroscience*, 8, Article 407
- [275] Yusuf, M. O. (2005). Information and Communication Technology and Education: Analysing the Nigerian National Policy for Information Technology. *International Education Journal*, 6(3), 316-321.)



- [276] Zabelina, D. L., & Robinson, M. D. (2010). Creativity as flexible cognitive control. *Psychology of Aesthetics, Creativity, and the Arts*, 4, 136–143. doi:10.1037/a0017379.
- [277] Zabelina, D. L., Robinson, M. D., Council, J. R., & Bresin, K. (2012). Patterning and non-patterning in creative cognition: Insights from performance in a random number generation task. *Psychology of Aesthetics, Creativity, and the Arts*, 6, 137–145.
- [278] Zajonc, R. B. (1980). Compresence. In P. B. Paulus (Ed.), *Psychology of Group Influence* (pp. 35–60). Hillsdale, NJ: Erlbaum.
- [279] Zegans, LS, Pollard, JC, Brown, D (1967) The effects of LSD-25 on creativity and tolerance to regression. *Arch Gen Psychiatry* 16: 740–749.
- [280] Zhao Q, Zhou Z, Xu H, Chen S, Xu F, Fan W, Han L. (2013) Dynamic neural network of insight: a functional magnetic resonance imaging study on solving Chinese ‘chengyu’ riddles. *PLoS one*. 2013;8(3):e59351. doi: 10.1371/journal.pone.0059351. Epub 2013 Mar 15
- [281] Csikszentmihalyi, M. (1997). *Flow and the Psychology of Discovery and Invention*. HarperPerennial, New York.
- [282] Bono, E. D. (1970). *Lateral Thinking. A Textbook of Creativity*. Londres: Ward Lock Educational,[1970]. Versión española: *El pensamiento lateral: manual de creatividad*.
- [283] Moran, G. S., & Alon, U. (2011). Playback theatre and recovery in mental health: Preliminary evidence. *The Arts in Psychotherapy*, 38(5), 318–324.
- [284] Stein, M. I. (1953). Creativity and culture. *The journal of psychology*, 36(2), 311–322.
- [285] Berkowitz, A. L., & Ansari, D. (2010). Expertise-related deactivation of the right temporoparietal junction during musical improvisation. *Neuroimage*, 49(1), 712–719.
- [286] Ciesielski, K. T., Harris, R. J., Hart, B. L., & Pabst, H. F. (1997). Cerebellar hypoplasia and frontal lobe cognitive deficits in disorders of early childhood. *Neuropsychologia*, 35(5), 643–655.
- [287] Coldren, J. T., & Halloran, C. (2003). Spatial reversal as a measure of executive functioning in children with autism. *The Journal of genetic psychology*, 164(1), 29–41.
- [288] Craig, J., & Baron-Cohen, S. (1999). Creativity and imagination in autism and Asperger syndrome. *Journal of Autism and Developmental Disorders*, 29(4), 319–326.
- [289] Dawson, L. M. (1995). Women and men, morality and ethics: sexual differences in moral reasoning. *Business Horizons*
- [290] Dawson, A. C. (1998). The intellectual commons: A rationale for regulation. *Prometheus*, 16(3), 275–289.
- [291] Gilotty, L., Kenworthy, L., Sirian, L., Black, D. O., & Wagner, A. E. (2002). Adaptive skills and executive function in autism spectrum disorders. *Child Neuropsychology*, 8(4), 241–248.
- [292] Ozonoff, S. (1995). Reliability and validity of the Wisconsin Card Sorting Test in studies of autism. *Neuropsychology*, 9(4), 491.
- [293] Ozonoff, S., & McEvoy, R. E. (1994). A longitudinal study of executive function and theory of mind development in autism. *Development and psychopathology*, 6(03), 415–431.
- [294] Planche, P. (2002). Information processing in autistic children: more sequential or more simultaneous?. *International journal of circumpolar health*, 61.
- [295] Rumsey, J. M., & Hamburger, S. D. (1988). Neuropsychological findings in high-functioning men with infantile autism, residual state. *Journal of Clinical and experimental Neuropsychology*, 10(2), 201–221.
- [296] Hughes, C., Leboyer, M., & Bouvard, M. (1997). Executive function in parents of children with autism. *Psychological Medicine*, 27(01), 209–220.
- [297] Hughes, C., Plumet, M. H., & Leboyer, M. (1999). Towards a cognitive phenotype for autism: increased prevalence of executive dysfunction and superior spatial span amongst siblings of children with autism. *Journal of Child Psychology and Psychiatry*, 40(05), 705–718.
- [298] Piven, J., Palmer, P., Jacobi, D., Childress, D., & Arndt, S. (1997). Broader autism phenotype: evidence from a family history study of multiple-incidence autism families. *American Journal of Psychiatry*, 154(2), 185–190.
- [299] Atlas, J. A., & Lapidus, L. B. (1987). Patterns of symbolic expression in subgroups of the childhood psychoses. *Journal of Clinical Psychology*, 43(2), 177–188.

- [300] Blanc, R., Adrien, J. L., Roux, S., & Barthélémy, C. (2005). Dysregulation of pretend play and communication development in children with autism. *Autism*, 9(3), 229-245.
- [301] Boucher, J. (2007). Memory and generativity in very high functioning autism A firsthand account, and an interpretation. *Autism*, 11(3), 255-264.
- [302] Frith, C. (2004). Is autism a disconnection disorder?. *The Lancet Neurology*, 3(10), 577.
- [303] Honey, E., Leekam, S., Turner, M., & McConachie, H. (2007). Repetitive behaviour and play in typically developing children and children with autism spectrum disorders. *Journal of Autism and Developmental Disorders*, 37(6), 1107-1115.
- [304] Turner, M. (1999). Annotation: Repetitive behaviour in autism: A review of psychological research. *Journal of child psychology and psychiatry*, 40(6), 839-849.
- [305] Hambrick, D. Z., & Tucker-Drob, E. M. (2014). The genetics of music accomplishment: Evidence for gene-environment correlation and interaction. *Psychonomic bulletin & review*, 1-9.
- [306] Chavez-Eakle, R., Graf-Guerrero, A., Garcia-Reyna, J., Vaugier, V., & Cruz-Fuentes, C. (2007). Cerebral blood flow associated with creative performance: A comparative study. *NeuroImage*, 38, 519-528. doi: 10.1016/j.neuroimage.2007.07.059.
- [307] Folley, B., & Park, S. (2005). Verbal creativity and schizotypal personality in relation to prefrontal hemispheric laterality: A behavioral and near-infrared optical imaging study. *Schizophrenia Research*, 80, 271-282. doi:10.1016/j.schres.2005.06.016.
- [308] Gibson, C., Folley, B. S., & Park, S. (2009). Enhanced divergent thinking and creativity in musicians: A behavioral and near-infrared spectroscopy study. *Brain and Cognition*, 69, 162-169. doi:10.1016/j.bandc.2008.07.009.
- [309] Hansen, P., Azzopardi, P., Matthews, P., & Geake, J. (2008, November). Neural correlates of "creative intelligence" An fMRI study of fluid analogies. Poster session presented at the annual conference of the Society for Neuroscience, New Orleans, LA.
- [310] Hori, H., Nagamine, M., Soshi, T., Okabe, S., Kim, Y., & Kunugi, H. (2008). Schizotypal traits in healthy women predict prefrontal activation patterns during a verbal fluency task: A near-infrared spectroscopy study. *Neuropsychobiology*, 57, 61-69. doi:10.1159/000129669
- [311] Sieborger, F., Ferstl, E., & von Cramon, Y. (2007). Making sense of nonsense: An fMRI study of task induced inference processes during discourse comprehension. *Brain Research*, 1166, 77-91. doi:10.1016/j.brainres.2007.05.079
- [312] Rose, M., Haider, H., Weiller, C., & Bu'chel, C. (2002). The role of medial temporal lobe structures in implicit learning: An event-related fMRI study. *Neuron*, 36, 1221-1231.
- [313] Rose, M., Haider, H., Weiller, C., & Bu'chel, C. (2005). Unconscious detection of implicit expectancies. *Journal of Cognitive Neuroscience*, 17, 918-927. doi:10.1016/S0896-6273(02)01105-4
- [314] Bengtsson, S., Csikszentmihalyi, M., & Ullen, F. (2007). Cortical regions involved in the generation of musical structures during improvisation in pianists. *Journal of Cognitive Neuroscience*, 19, 830-842. doi:10.1162/jocn.2007.19.5.830
- [315] Berkowitz, A., & Ansari, D. (2008). Generation of novel motor sequences: The neural correlates of musical improvisation. *NeuroImage*, 41, 535-543. doi:10.1016/j.neuroimage.2008.02.028
- [316] Brown, S., Martinez, M., & Parsons, L. (2006). Music and language side by side: A PET study of the generation of sentences. *European Journal of Neuroscience*, 23, 2791-2803. doi:10.1111/j.1460-9568.2006.04785.x
- [317] Kowatari, Y., Lee, S., Yamamura, H., Nagamori, Y., Levy, P., Yamane, S., & Yamamoto, M. (2009). Neural networks involved in artistic creativity. *Human Brain Mapping*, 30, 1678-1690. doi:10.1002/hbm.20633
- [318] Solso, R. (2001). Brain activities in a skilled versus a novice artist: An fMRI study. *Leonardo*, 34, 31-34. doi:10.1162/002409401300052479
- [319] Buckner, R. L., Andrews-Hanna, J. R., & Schacter, D. L. (2008). The Year in Cognitive Neuroscience 2008.
- [320] Claridge, G. S. (1990). Can a disease model of schizophrenia survive. *Reconstructing schizophrenia*, 157-183.



- [321] Nettle, D. (2001). *Strong imagination: Madness, creativity and human nature*. Oxford University Press.
- [322] Bartolic, E. I., Basso, M. R., Schefft, B. K., Glauser, T., & Titanic-Schefft, M. (1999). Effects of experimentally-induced emotional states on frontal lobe cognitive task performance. *Neuropsychologia*, 37(6), 677-683.
- [323] De Dreu, C. K., Baas, M., & Nijstad, B. A. (2008). Hedonic tone and activation level in the mood-creativity link: toward a dual pathway to creativity model. *Journal of personality and social psychology*, 94(5), 739.
- [324] Chamberlain, S. R., Müller, U., Blackwell, A. D., Clark, L., Robbins, T. W., & Sahakian, B. J. (2006). Neurochemical modulation of response inhibition and probabilistic learning in humans. *Science*, 311(5762), 861-863.
- [325] Sulloway, F. J. (1996). *Born to rebel: Birth order, family dynamics, and creative lives*. Pantheon Books.
- [326] Levy Tacher, E., & Anderson Readdick, C. (2006). The relation between aggression and creativity among second graders. *Creativity Research Journal*, 18(3), 261-267.
- [327] Troyer, L., & Younggreen, R. (2009). Conflict and creativity in groups. *Journal of Social Issues*, 65(2), 409-427.
- [328] Gino, F., & Ariely, D. (2012). The dark side of creativity: original thinkers can be more dishonest. *Journal of personality and social psychology*, 102(3), 445.
- [329] Batey, M., & Furnham, A. (2006). Creativity, intelligence, and personality: A critical review of the scattered literature. *Genetic, Social, and General Psychology Monographs*, 132(4), 355-429.
- [330] Qian, M., Plucker, J. A., & Shen, J. (2010). A model of Chinese adolescents' creative personality. *Creativity Research Journal*, 22(1), 62-67.
- [331] Anderson, N., & West, M. A. (1996). The Team Climate Inventory: Development of the TCI and its applications in teambuilding for innovativeness. *European Journal of work and organizational psychology*, 5(1), 53-66.
- [332] Shalley, C. E., & Gilson, L. L. (2004). What leaders need to know: A review of social and contextual factors that can foster or hinder creativity. *The Leadership Quarterly*, 15(1), 33-53.
- [333] Anderson, N., De Dreu, C. K., & Nijstad, B. A. (2004). The routinization of innovation research: A constructively critical review of the state of the-science. *Journal of organizational Behavior*, 25(2), 147-173.
- [334] Meador, G. (1994). National Science Education Reforms: Are We on the Road to a National Curriculum. ERIC# ED311412.
- [335] Castillo, L. C. (1998). The effect of analogy instruction on young children's metaphor comprehension. *Roeper Review*, 21(1), 27-31.
- [336] CLAPHAM, M., & Schuster, D. H. (1992). Can Engineering Students be Trained to Think More Creatively?. *The Journal of Creative Behavior*, 26(3), 156-162.
- [337] Schott, G., & Burn, A. (2004). Art (re) production as an expression of collective agency within Oddworld Fan-culture. *Works & Days, Capitalizing on Play: Politicized Readings of the Computer Game Industry*, 22(1), 251-274.
- [338] Bull, K. S., Montgomery, D., & Baloche, L. (1995). Teaching creativity at the college level: A synthesis of curricular components perceived as important by instructors. *Creativity Research Journal*, 8(1), 83-89.
- [339] Noller, R. B., & Parnes, S. J. (1972). Applied Creativity: The creative studies project. *The Journal of Creative Behavior*, 6(4), 275-294.
- [340] Covington, M. V., Crutchfield, R. S., & Davies, L. B. (1966). *The productive thinking process, series I, general problem-solving*. Berkeley: Breselton Printing Company.
- [341] Mansfield, R. S., Busse, T. V., & Krepelka, E. J. (1978). The effectiveness of creativity training. *Review of Educational Research*, 517-536.
- [342] Feuerstein, G. (1980). *The Bhagavad-Gītā: yoga of contemplation and action*. Arnold-Heinemann.
- [343] Arbitman-Smith, R., Haywood, H. C., & Bransford, J. D. (1984). Assessing cognitive change. *Learning and cognition in the mentally retarded*, 433-471.
- [344] Nickerson, R. S. (1999). 20 Enhancing Creativity. *Handbook of creativity*, 392.
- [345] Ritchie, S. M., & Edwards, J. (1996). Creative thinking instruction for aboriginal children. *Learning and Instruction*, 6(1), 59-75.
- [346] Feldhusen, J. F. (1983). The Purdue creative thinking program. *Creativity research and educational planning*, 41-46.

- [347] Feldhusen, J. F., & Kennedy, D. M. (1988). Preparing gifted youth for leadership roles in a rapidly changing society. *Roeper Review*, 10(4), 226-230.
- [348] Speedie, S. M., Treffinger, D. J., & Feldhusen, J. F. (1971). Evaluation of components of the Purdue Creative Thinking Program: a longitudinal study. *Psychological Reports*, 29(2), 395-398.
- [349] Reis, S. M., & Renzulli, J. S. (2010). Is there still a need for gifted education? An examination of current research. *Learning and individual differences*, 20(4), 308-317.
- [350] Renzulli, J. S., & Reis, S. M. (1985). Scope and Sequence Approach to Process Development. *G/C/T*, 37, 2-6.
- [351] Bodrova, E., & Leong, D. J. (2001). Tools of the Mind: A Case Study of Implementing the Vygotskian Approach in American Early Childhood and Primary Classrooms. *Innadata Monographs* 7.
- [352] Diamond, A., Barnett, W. S., Thomas, J., & Munro, S. (2007). Preschool program improves cognitive control. *Science (New York, NY)*, 318(5855), 1387.
- [353] Beghetto, R. A., & Kaufman, J. C. (Eds.). (2010). *Nurturing creativity in the classroom*. Cambridge University Press.
- [354] Bransford, J. D., Brown, A. L., & Cocking, R. R. (2000). *How people learn*.
- [355] Torrance, E. (1972). Can We Teach Children To Think Creatively?. *The Journal of Creative Behavior*, 6(2), 114-143.
- [356] Glass, G. V., McGaw, B., & Smith, M. L. *Meta-analysis in social research*, 1981. Beverly Hills: Sage Publications.
- [357] Balota, D. A., & Spieler, D. H. (1999). Word frequency, repetition, and lexicality effects in word recognition tasks: beyond measures of central tendency. *Journal of Experimental Psychology: General*, 128(1), 32.
- [358] Noller, R. B., Parnes, S. J., & Biondi, A. M. (1976). *Creative actionbook: revised edition of creative behaviour workbook*. Charles Scriber's Sons.
- [359] 359. Camp, G. C. (1994). A longitudinal study of correlates of creativity. *Creativity Research Journal*, 7(2), 125-144.
- [360] 360. Montuori, A. (1992). Creativity, chaos, and self-renewal in human systems. *World Futures: Journal of General Evolution*, 35(4), 193-209.
- [361] Bruner J. The growth of mind. *Am. Psychol.* 1965; 20:1007-1017.
- [362] Ullén, F., Mosing, M. A., Holm, L., Eriksson, H., & Madison, G. (2014) Psychometric properties and heritability of a new online test for musicality, the Swedish Musical Discrimination Test. *Personality and Individual Differences* 63, 87-93
- [363] Brownlee, K. E. (2013) *Gossip, Exclusion, Competition, and Spite: A Look Below the Glass Ceiling at Female-to-Female Communication Habits in the Workplace*. Master's Thesis, University of Tennessee.
- [364] Ekvall, G. (1996). Organizational climate for creativity and innovation. *European journal of work and organizational psychology*, 5(1), 105-123
- [365] National Advisory Committee on Creative and Cultural Education (NACCCE) (1999). *All our futures: Creativity, culture and education*. London: HMSO.
- [366] Perkins K. K., Wieman C. E. Innovative teaching to promote innovative thinking. In: DeHaan R. L., Narayan K.M.V., editors. *Education for Innovation: Implications for India, China and America*. Rotterdam, The Netherlands: Sense Publishers; 2008. pp. 181-210
- [367] Cloud-Hanson K. A., Kuehner J. N., Tong L., Miller S., Handelsman J. Money, sex and drugs: a case study to teach the genetics of antibiotic resistance. *CBE Life Sci. Educ.* 2008;7:302-309.
- [368] De Bono, Edward, 1973, *CoRT Thinking Programme, Workcards and Teacher's Notes*, : Direct Education Services

Glossary

Brain imaging or neuroimaging is a set of noninvasive technologies that produce images of the structure or activity of the brain or other part of the nervous system; examples are magnetic resonance imaging or computerized tomography

Cingular cortex, anterior cingular cortex is a part of the brain situated in the medial aspect of the cerebral cortex. It is an integral part of the limbic system, which is involved with emotion formation and processing, learning, and memory.

Cognitive psychology is the study of mental processes such as “attention, language use, memory, perception, problem-solving, creativity and thinking.

Cognitive neuroscience is an academic field concerned with the scientific study of biological substrates underlying cognition, with a specific focus on the neural substrates of mental processes.

Conceptual expansion is the ability to widen one’s structured memory networks to include unusual or novel associations.

Convergent thinking is the ability to find a single correct solution for a given problem.

Creativity is the ability to make new things or think of new ideas. Such ideas should be original and useful.

Crystallized intelligence pertains to the part of intelligence due to acquired information; it is most often obtained through education.

Default mode network is a functional network in the brain that is active when people are at rest.

Divergent thinking is the ability to think of as many solutions as possible for a certain problem.

Domain is a field or an academic area.

Dopamine is a neurotransmitter, one of the chemicals that helps neurons transmit electrical currents among them. It is involved in many functions, such as rewards mood, emotion, motivation, and creativity.

Elaboration refers to the level of detail in responses; for instance, ‘keeping headphones from getting tangled up’ would be worth more than ‘bookmark’ in the paper clip test.

Executive attention network is a functional network in the brain that is active when people are concentrated in various tasks.

Executive functions is an umbrella term for the management, regulation, and control of cognitive processes. These include reasoning, task flexibility, problem-solving as well as planning, and execution within working memory limits.

Flexibility is the ability to switch between thinking about two different concepts or tasks, and to think about multiple concepts simultaneously.

Fluency is the rate of responses per minute in a test of creativity, such as discrete solutions generated for various objects.

Fluid intelligence is the more genetically determined part of intelligence.

Functional fixedness is a cognitive bias that limits a person to using an object only in the way it is traditionally used. The bias can prevent us from seeing the full range of ways in which an object can be used.

Functional networks in the brain are areas that are linked while certain functions are performed. Examples are the default mode and the 'attentional' networks.

Insights are sporadic, unpredictable, short-lived moments of exceptional thinking where unwarranted assumptions need to be discarded before solutions to problems can be obtained. Insight requires a restructuring of the problem situation, break apart chunks of knowledge (mental sets), to select the semantic information and to form novel, task-related associations.

Intuition involves coming to a conclusion or making a judgment without awareness of the thought processes involved. The phenomenon probably involves an unconscious contemplation of information.

Lateral inhibition is a person's ability to filter out irrelevant stimuli.

Lateral thinking is solving problems through an indirect and creative approach, using reasoning that is not immediately obvious and involving ideas that may not be obtainable by using only traditional step-by-step logic. The term was coined in 1967 by Edward de Bono.

Long-term memory is the relatively permanent store of declarative and implicit knowledge that people have. It is set up in the form of networks. Knowledge items are bound in complex relations to each other and under hierarchical systems.

Memory network is a conceptual representation that views memory as consisting of a set of nodes and interconnecting links where nodes represent stored information or concepts, and links represent the strength of association between this information or concepts. Similar terms are knowledge network, semantic network, cognitive network.

Mental set is the tendency to persist in solving problems the 'old' way, which limits our ability to recognize new alternative solutions.

Neuroimaging: see brain imaging.

Nucleus accumbens is a part of the brain that is associated with motivation, pleasure, and addiction. It is involved in lateral inhibition, that is suppressing unwanted stimuli. Dopamine receptors modulate this function.

Number line: In basic mathematics, a number line is a picture of a straight line on which every point is assumed to correspond to a real number. It is often used as an aid in teaching simple addition and subtraction.

OECD is the Organization for Economic Development and Cooperation. An international economic organization of 34 countries founded in 1961, OECD's mission is to promote policies that will improve the economic and social well-being of people around the world.

Originality is the rarity of responses in a creativity test.

Overcoming knowledge constraints is the ability to override 'functional fixedness', the constraining influence imposed by salient or pertinent knowledge.

Persistence is the ability to use many or broad cognitive categories but also to generate many ideas within a few categories.

Persistence refers to prolonged efforts made while trying to find a creative solution to an impasse.

PISA is the OECD's Programme for International Student Assessment, a triennial international survey which aims to evaluate education systems worldwide by testing the skills and knowledge of 15-year-old students.

Precuneus is a brain area that is a part of the superior parietal lobule forward of the occipital lobe. It is a part of the default mode network and is strongly activated when people are at rest.

Schizotypy is a continuum of personality characteristics and experiences. Schizoid people may appear odd or eccentric. They may have vivid fantasies and may be loners, distant, detached, and indifferent to social relationships; they may prefer solitary activities and rarely express strong emotion.

Serotonin is a neurotransmitter, one of the chemicals that helps neurons transmit electrical currents among them. Serotonin is often involved in appetite and mood.

Working memory is what is in your mind right now. This mechanism has very limited capacity. It can hold only 4-7 items for about 12 to 25 seconds.





Explorations of Creativity

A review for educators and policy making

02

Creativity is the driving force of human evolution.

In our early 21st century the demand for creative thinkers is particularly high. Interest in creativity has generated countless studies, books, and articles. Which popular beliefs about creativity are valid? In this comprehensive and accessible review, multiple strands of research are woven together revealing intriguing mechanisms and linkages in the creative process. The work dramatizes the powerful implications of creativity for learning, and suggests how we may benefit from these insights at any age.

Dr. Helen Abadzi, a psychologist, has spent 27 years as a Senior Education Specialist at the World Bank. She has drawn on cognitive psychology and neuroscience to improve the outcomes of educational investments. **Prof. Marialuisa Martelli** is a researcher in the Department of Psychology at the University of Rome La Sapienza and **Silvia Primativo** is a doctoral student at the same university.

wise

world innovation summit for education
مؤتمر القمة العالمي للابتكار في التعليم

an initiative of مؤساسة قطر
Qatar Foundation 